

# Product catalogue

Cleaning systems for maximum performance and profit



Proudly North American



# We all take care

Vileda Professional's view on sustainability

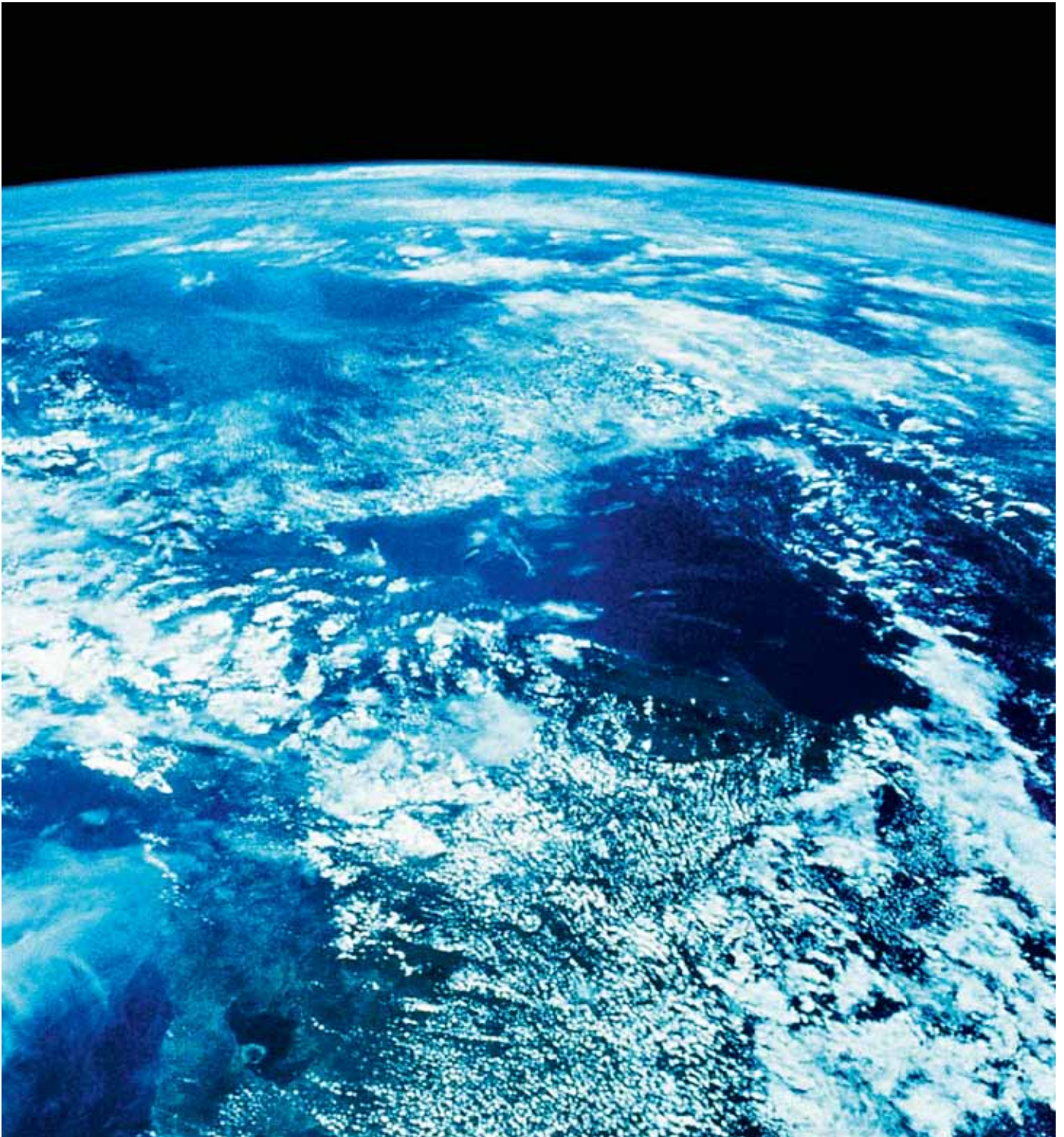

# Responsibility for the future

Caring for the future is nothing new to us. We've been on that road for several years and we will stay on it for as long as we are active in the industrial world.

## What does our dedication to sustainability mean to you?

That the products you use are developed for maximum cleaning performance and for effective waste management. That production processes and logistics have been optimised for as low environmental impact as possible.

Quite simply – an environmental peace of mind.

## “We all take care”

The Freudenberg Group – where Vileda Professional is a part – has had a clear sustainability approach for many years. Already in 1889 the company started a corporate citizenship program, including several voluntary social and welfare services.

And in 2003 the powerful internal program “We all take care” was launched to encourage every associate to contribute ideas and suggestions in terms of improving safety at work and environmental protection for both colleagues and neighbours.

So we are fully aware that sustainability is an ongoing everyday-challenge and has to be continuously implemented and lived by every member of the company.

## Sustainable cleaning logo

From our extensive product portfolio, we have selected a range of products that meet specific criteria from a sustainability point of view. Using them in the daily cleaning business is a contribution to taking care for future generations. Also you can be sure that taking on a clear sustainability approach will strengthen the competitive edge to your business.



Look for this logo to easily identify our ever growing family of sustainable products

For many years Vileda Professional has had a clear approach to sustainability. We develop and market high performance products that are durable, washable, re-usable and with an ergonomic focus.

From our extensive product portfolio, we have selected a range of products that meet specific criteria from a sustainability point of view. Using them in the daily cleaning business is a contribution to taking care for future generations. Also you can be sure that taking on a clear sustainability approach will strengthen the competitive edge to your business.

## Top performance. Top-of-the-line products.

Sustainability criteria is one side of this product selection, the other is of course cleaning performance in all its senses.

Fast, effective cleaning with top economy and ergonomics will make a substantial impact on both the cleaning result and on your bottom line figures!

## Sustainability Criteria

Our products are classified as “sustainable” when one or more of the following criteria are fulfilled.

- |                          |  |
|--------------------------|--|
| <b>Efficiency:</b>       | > 25% savings gained in at least one of the criteria: <ul style="list-style-type: none"><li>• Time needed.</li><li>• Water consumption.</li><li>• Chemicals consumption.</li></ul> |
| <b>Hygiene:</b>          | Ability to remove min. 99% of bacteria.  |
| <b>Ergonomics:</b>       | Tested internationally or certified by independent institute.  |
| <b>Laundering:</b>       | Saves > 25% cost during washing process (e.g. higher washloads).   |
| <b>Durability:</b>       | > 300 washes (for textiles).   |
| <b>Raw materials:</b>    | > 50% recycled or renewable.   |
| <b>Biodegradability:</b> | Product is biodegradable.  |

# Symbols & technical icons

## Application areas

Health  
Care



General  
Building



HoReCa  
(Hotel, Restaurant, Catering)



= Best choice



= Good choice

## Colour coding



With the aid of Vileda Professional's Quattro colour-coding system, it's easy to avoid poor hygiene and cross-contamination. Any product with the Quattro symbol is available in at least four colours.



## Technical icons

All the Vileda Professional – Marino products hold a high standard of quality, which means low costs for you in both the short and long-term. The technical icons may show both recommended cleaning methods and laundry advice. Follow the recommendations to get full value from our product.



Washing  
Temperature



No chlorine /  
whitener



Tumble dry



Do not  
tumble dry



**Cleaning methods**

Shows the ideal cleaning method.

Wet Damp Dry

Vileda Professional – Marino reserves the right to modify or change specification of a product for greater performance or improvement at any time.





# Index.

## FLOOR CLEANING

7

<b>Mops</b>	8-48
Wet mops	
Dust mops	
Flat mopping systems	
Miscellaneous	
<b>Buckets &amp; wringers</b>	49-57
<b>Brooms</b>	59 -79
<b>Brushes</b>	81-86
<b>Floor squeegees</b>	87-89
<b>Trolleys</b>	90-99

## ABOVE THE FLOOR CLEANING 99

<b>Wiping</b>	100-105
<b>Sponges &amp; scourers</b>	106-107
<b>Dusters</b>	108-110
<b>Window cleaning</b>	112-119

## OTHER CLEANING TOOLS 117

<b>Waste management</b>	120-127
<b>Washroom care</b>	128-136

## PRIVATE LABEL PROGRAM 137

<b>Index</b>	138
--------------	-----

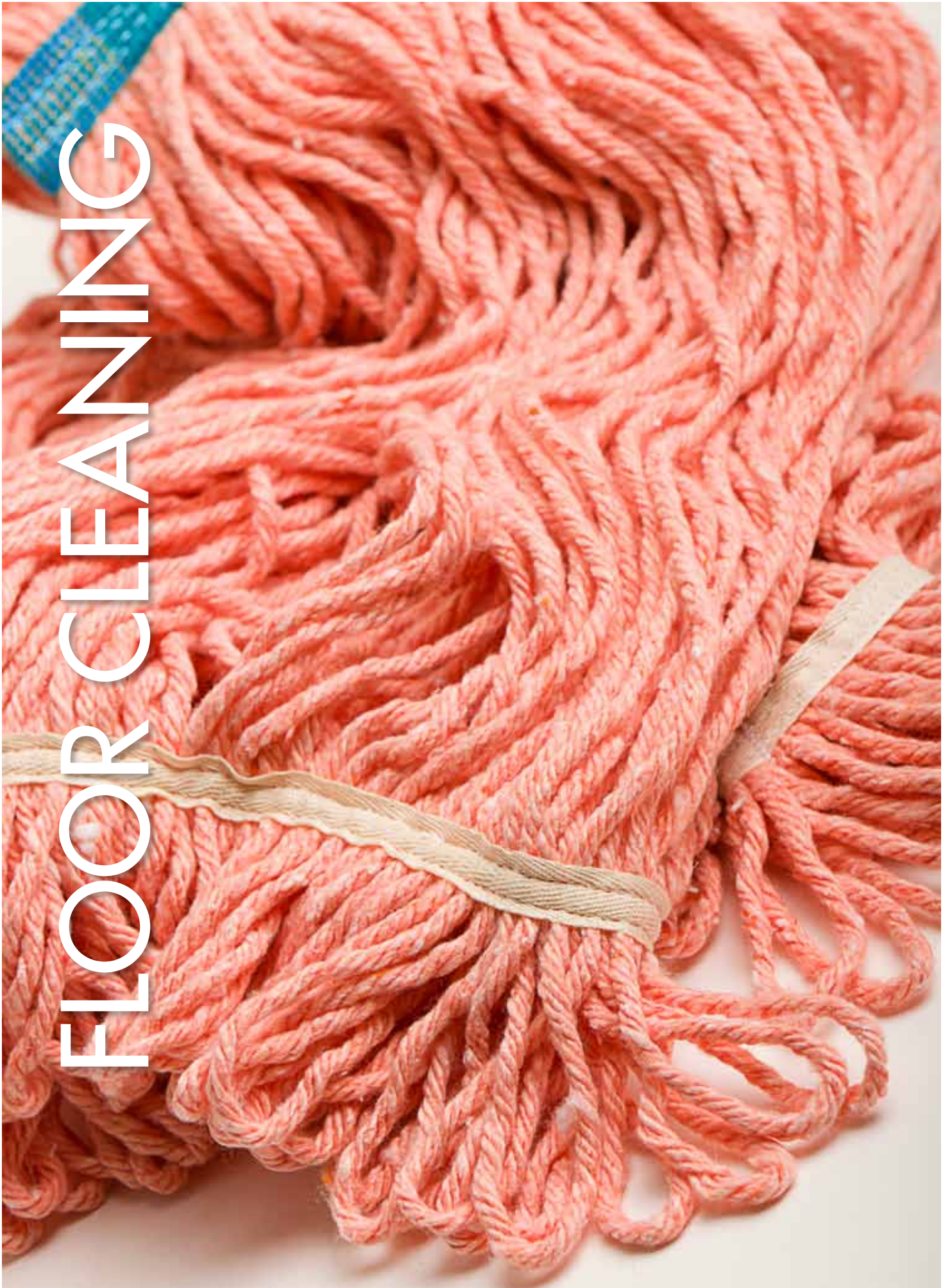

# FLOOR CLEANING

# Floor Cleaning

<b>WET MOPS</b>	<b>8 – 23</b>	
Wet Mops Selection Process		
Looped Mops		
Cut End Mops		
Fantail Mops		
Specialty Wet Mops		
Handles		
Mop Laundry Net		
<b>DUST MOPS</b>	<b>25 – 32</b>	
Dust Mops Selection Process		
Break Away Dust Mops		
Tie On Dust Mops		
Specialty Dust Mops		
<b>FLAT MOPPING SYSTEMS</b>	<b>33 – 46</b>	
Choosing the right flat mopping system		
UltraSpeed		
Spray Express		
SWEP		
MicroPad Cleaning System		
Wall Washing		
Wall Washing System		
Doodle Bug Wall Washing System		
<b>MISCELLANEOUS</b>	<b>47 – 48</b>	
Wet Floor Signs		
Wax Applicators		
<b>BUCKETS &amp; WRINGERS</b>	<b>49 – 57</b>	
Ultraflex System		
Traditional		
Buckets		
Wringers		
Bucket & Wringer Combo's		
Utility Buckets & Pails		
<b>BROOMS</b>	<b>58 – 79</b>	
Choosing the right broom		
Push Brooms		
Trooper Brooms		
Complete Push Brooms		
Fine Sweep		
Medium Sweep		
Course Sweep		
Food Service Brooms		
Corn Brooms		
Magnetic Brooms		
Rail/ Switch Broom		
Handles		
Miscellaneous		
Dustpans		
Braces		
Brackets		
Tool Bracket Holder		
Display Stand		
<b>BRUSHES</b>	<b>80 – 86</b>	
Whitewash/ Masonry Brushes		
Counter Brushes		
Vehicle Brushes		
Acid Resistant Brushes		
Window Brushes		
Window/ Baseboard Brushes		
Utility Deck Scrub Brushes		
Hand Scrubs		
Iron Style Hand Scrubs		
Hand and Nail Brushes		
Food Service Brushes		
Bi-Level Brushes		
Wire Scratch Brushes		
Twisted Pro Scrubs		
Boot and Shoe Cleaner		
<b>FLOOR SQUEEGEES</b>	<b>87 – 89</b>	
Metal Frame Squeegees		
MUS Squeegees		
Plastic Pro Squeegees		
Handles		
<b>TROLLEYS</b>	<b>90 – 99</b>	
Create		
The Origo Series		
VoleoFlex Series		
Janitorial Carts		

## Traditional Wet Mops - The Right Choice

Generally speaking, mops do not wear out through use, but rather abuse. We have outlined a few basic maintenance tips that will extend the life of your mop and its efficiency.

### Mop Basics

1. Break-in new mop heads in warm, mild detergent solution for at least 20 minutes.
2. Avoid strong cleaning solutions that will cause the strands to break more quickly.
3. Always rinse and wring out mops after every usage.
4. Store mop heads by hanging in a warm, dry, well-ventilated area.
5. Avoid scrubbing with the top portion of the mop head, as this will tear the strands and shorten the mop life.
6. When mopping rough surfaces, always mop in the direction that minimizes snagging.

### Cut End VS Looped-End mops

#### Cut End Mops

Cut End mops are the most popular due to their lower initial purchase price, therefore they are seen as more economical.

However, cut end mops are not supposed to be laundered, and are most often thrown in the trash far before they should be. This in turn creates more waste in our landfills, and has a negative effect on the environment. Cut-end mops also unravel with use, and tend to lint.

#### Looped End Mops

It has been stated that looped end mops outlast cut-end mops 7:1. It is no secret in the industry that looped mops have superior performance, and last far longer than cut end mops. Additionally, their tailband provides higher mopping coverage, and prevents unravelling. Overall looped-end mops are a more environmentally friendly and economical choice.



#### Mesh Headband

- Poly coated for maximum performance and durability
- Quality Stitching
- Stylish Navy Blue



#### Tailband Tape

- Prevents tangles
- Wider surface coverage
- Improves commercial lauderability



#### Absorbency

- Faster drying times
- Allows for greater surface area to be cleaned









#### Durability

- Quality synthetic yarns such as MicroEco and The Looper increase the longevity of the mops



#### Performance

- A high degree of debris pick-up in a wide variety of floor surfaces

Mop Types	Features	Benefits	Additional Information						
 <b>MicroEco</b>	<ul style="list-style-type: none"> <li>• Made with recycled PET bottles</li> <li>• Microfiber technology</li> <li>• Strength and durability</li> <li>• Constructed using four ply yarn</li> <li>• Looped end design</li> </ul>	<ul style="list-style-type: none"> <li>• Less harmful on the environment</li> <li>• Minimized linting</li> <li>• Long life span</li> <li>• High resistance to chemicals</li> <li>• Strength and durability</li> <li>• Looped mops prevent tangling, fraying and linting</li> </ul>	<p><b>Pallet Quantity</b></p> <table border="0"> <tr> <td>12 oz -16 oz</td> <td>54 cases</td> </tr> <tr> <td>20 oz -24 oz</td> <td>54 cases</td> </tr> <tr> <td>32 oz</td> <td>45 cases</td> </tr> </table> <p><b>Recommended Frame and Handle</b></p> <p><b>Narrow Band (NB)</b></p> <ul style="list-style-type: none"> <li>• Snap-N-Go</li> <li>• Quick Change</li> </ul> <p><b>Wide Band (WB)</b></p> <ul style="list-style-type: none"> <li>• Snap-N-Go</li> <li>• Jaw Breaker</li> </ul>	12 oz -16 oz	54 cases	20 oz -24 oz	54 cases	32 oz	45 cases
12 oz -16 oz	54 cases								
20 oz -24 oz	54 cases								
32 oz	45 cases								
 <b>The Looper</b>	<ul style="list-style-type: none"> <li>• Available in three colours</li> <li>• High absorbency</li> <li>• Extremely durable</li> <li>• Made with five ply yarn</li> <li>• Looped end design</li> </ul>	<ul style="list-style-type: none"> <li>• Colour coded (reduce cross contamination)</li> <li>• Minimized linting</li> <li>• Can be laundered up to 60 times (Long life span)</li> <li>• Looped mops prevent tangling, fraying and linting</li> </ul>							
 <b>Sentrex</b>	<ul style="list-style-type: none"> <li>• Synthetic/ rayon blend of yarn</li> <li>• High absorbency</li> <li>• Available in looped and cut end</li> </ul>	<ul style="list-style-type: none"> <li>• Long-lasting / superior quality</li> <li>• Depending on price point the user has the option to buy cut end mop with same quality yarn</li> </ul>							
 <b>Winger</b>	<ul style="list-style-type: none"> <li>• Cost effective high quality yarn</li> <li>• Superior absorbency</li> <li>• Looped end design</li> </ul>	<ul style="list-style-type: none"> <li>• Great performance with less investment</li> <li>• Looped mops prevent tangling, fraying and linting</li> </ul>							
 <b>ValueLine</b>	<ul style="list-style-type: none"> <li>• Cost effective</li> <li>• Blend of cotton and synthetic fibers</li> </ul>	<ul style="list-style-type: none"> <li>• Easily affordable</li> <li>• Strength of synthetic</li> </ul>							
 <b>Cotton</b>	<ul style="list-style-type: none"> <li>• Excellent water absorption</li> <li>• Made with a durable cotton yarn</li> <li>• Available in looped and cut end</li> </ul>	<ul style="list-style-type: none"> <li>• Cleaner can cover more surface area of the floor</li> <li>• Rugged cleaning in high traffic areas</li> <li>• Easily affordable</li> </ul>							



## MicroEco™ – Looped End Mop



**Go green...** naturally, with our MicroEco Mop made of post-consumer PET plastic soda bottles and revolutionary Microfiber technology. The advantages of utilizing microfiber yarn are: minimized linting, high resistance to chemicals & disinfectants resulting superior mop.

Our New MicroEco Mop is just another step in helping preserve our natural resources as it prevents thousands of bottles from becoming landfill waste. Together, we can all commit in doing our part to protecting the environment.

This unique 4 ply yarn is manufactured from a combination of 2 strands of Microfiber yarn and 2 strands of Green PET synthetic fibers derived from plastic bottles.

- All mops are individually poly-bagged.
- Available in narrow band (4.3 cm/ 1.75 in) and wide band (12.6 cm/ 5 in)
- Suitable for Healthcare



Old Product Code	NEW Code	Product Description - Narrow Band	Size	Pack	Application
MP-ME3000	134906	MicroEco mop – Small – 4 row stitched – narrow band	Small	12	
MP-ME3001	134907	MicroEco mop – Medium – 4 row stitched – narrow band	Medium	12	
MP-ME3002	134908	MicroEco mop – Large – 4 row stitched – narrow band	Large	12	
Old Product Code	NEW Code	Product Description - Wide Band	Size	Pack	Application
MP-ME3010	134909	MicroEco mop –Small – 6 row stitched – wide band	Small	12	
MP-ME3011	134911	MicroEco mop – Medium – 6 row stitched – wide band	Medium	12	
MP-ME3012	131604	MicroEco mop – Large – 6 row stitched – wide band	Large	12	

## The Looper - Narrow Band



- The best choice available in traditional wet mopping.
- Ideal for hospitals and nursing homes where high standards and strict requirements are easily satisfied.
- Made from a unique blend of yarn that enables superior absorbency while withstanding repeated commercial laundering up to 60 times.
- Heavy duty poly coated headband mesh withstands harsh chemicals, launderings for the life of the mop and abuse when headband is used as a scrubber.
- Looped-end construction allows for maximum floor coverage while eliminating tangling, fraying and linting.

- Made without any cotton fiber
- Avoid cross-contamination with colour coded mops.
- Available in 3 colours – 5 ply yarn.
- All mops are individually poly-bagged.
- Available in both narrow band (4.3 cm / 1.75 in) and wide band (12.6 cm/ 5 in).



### Recommended frames:

- Snap-N-Go
- Jaw Breaker

BL GR OR  
 PLEASE SPECIFY COLOUR WHEN ORDERING.

Old Product Code	NEW Code	Product Description - Narrow Band	Size	Pack	Application
MPLMXS-BL	134899	The Looper, 6 row stitched, narrow band – blue	X-Small	12	
MPLMXS-GR	134900	The Looper, 6 row stitched, narrow band – green	X-Small	12	
MPLMXS-OR	134901	The Looper, 6 row stitched, narrow band – orange	X-Small	12	
MPLMS-BL	134884	The Looper, 6 row stitched, narrow band – blue	Small	12	
MPLMS-GR	134885	The Looper, 6 row stitched, narrow band – green	Small	12	
MPLMS-OR	134886	The Looper, 6 row stitched, narrowband – orange	Small	12	
MPLMM-BL	134878	The Looper, 6 row stitched, narrow band – blue	Medium	12	
MPLMM-GR	134879	The Looper, 6 row stitched, narrow band – green	Medium	12	
MPLMM-OR	134880	The Looper, 6 row stitched, narrow band – orange	Medium	12	
MPLML-BL	134871	The Looper, 6 row stitched, narrow band – blue	Large	12	
MPLML-GR	134872	The Looper, 6 row stitched, narrow band – green	Large	12	
MPLML-OR	134873	The Looper, 6 row stitched, narrow band – orange	Large	12	
MPLMXL-BL	134893	The Looper, 6 row stitched, narrow band – blue	X-Large	12	
MPLMXL-GR	134894	The Looper, 6 row stitched, narrow band – green	X-Large	12	
MPLMXL-OR	134895	The Looper, 6 row stitched, narrow band – orange	X-Large	12	

## The Looper - Wide Band



- The best choice available in traditional wet mopping.
  - Ideal for hospitals and nursing homes where high standards and strict requirements are easily satisfied.
  - Made from a unique blend of yarn that enables superior absorbency while withstanding repeated commercial laundering up to 60 times.
  - Heavy duty poly coated headband mesh withstands harsh chemicals, launderings for the life of the mop and abuse when headband is used as a scrubber.
  - Looped-end construction allows for maximum floor coverage while eliminating tangling, fraying and linting.
  - Made without any cotton fiber
- Avoid cross-contamination with colour coded mops.
  - Available in 3 colours – 5 ply yarn.
  - All mops are individually poly-bagged.
  - Available in both narrow band (4.3 cm / 1.75 in) and wide band (12.6 cm/ 5 in).



### Recommended frames:

- Snap-N-Go
- Jaw Breaker

BL GR OR  
 PLEASE SPECIFY COLOUR WHEN ORDERING.

Old Product Code	NEW Code	Product Description - Wide Band	Size	Pack	Application
MPLMXSW-BL	134902	The Looper, 6 row stitched, wide band – blue	X-Small	12	
MPLMXSW-GR	134904	The Looper, 6 row stitched, wide band – green	X-Small	12	
MPLMXSW-OR	134905	The Looper, 6 row stitched, wide band – orange	X-Small	12	
MPLMSW-BL	134887	The Looper, 6 row stitched, wide band – blue	Small	12	
MPLMSW-GR	134889	The Looper, 6 row stitched, wide band – green	Small	12	
MPLMSW-OR	134891	The Looper, 6 row stitched, wide band – orange	Small	12	
MPLMMW-BL	131598	The Looper, 6 row stitched, wide band – blue	Medium	12	
MPLMMW-GR	134882	The Looper, 6 row stitched, wide band – green	Medium	12	
MPLMMW-OR	134883	The Looper, 6 row stitched, wide band – orange	Medium	12	
MPLMLW-BL	134874	The Looper, 6 row stitched, wide band – blue	Large	12	
MPLMLW-GR	134876	The Looper, 6 row stitched, wide band – green	Large	12	
MPLMLW-OR	134877	The Looper, 6 row stitched, wide band – orange	Large	12	
MPLMLW-BL	134896	The Looper, 6 row stitched, wide band – blue	X-Large	12	
MPLMLW-GR	134897	The Looper, 6 row stitched, wide band – green	X-Large	12	
MPLMLW-OR	134898	The Looper, 6 row stitched, wide band orange	X-Large	12	

## Sentrex Looper™ – Narrow Band



- Ideal for rugged cleaning on rough surfaces and high traffic areas.
- Made from a highly durable synthetic/rayon blended yarn with superior tensile strength properties.
- Delivers high absorbency and can withstand repeated laundering without linting.
- Heavy duty poly coated headband mesh withstands harsh chemicals, launderings for the life of the mop and abuse when headband is used as a scrubber.
- Looped-end construction and fan-tail design allows for maximum floor coverage while eliminating tangling and fraying.
- All mops are individually poly-bagged.
- Available in narrow band (4.3 cm/ 1.75 in) and wide band (12.6 cm/ 5 in).

### Recommended frames:

- Snap-N-Go
- Quick Change

Old Product Code	NEW Code	Product Description - <b>Narrow Band</b>	Size	Pack	Application
MP4PSSL	134858	Sentrex Looper, blue mesh, 6 row stitched, narrow band	Small	12	  
MP4PSML	134854	Sentrex Looper, blue mesh, 6 row stitched, narrow band	Medium	12	  
MP4PSLL	134850	Sentrex Looper, blue mesh, 6 row stitched, narrow band	Large	12	  

## Sentrex Looper™ – Wide Band



- Ideal for rugged cleaning on rough surfaces and high traffic areas.
- Made from a highly durable synthetic/rayon blended yarn with superior tensile strength properties.
- Delivers high absorbency and can withstand repeated laundering without linting.
- Heavy duty poly coated headband mesh withstands harsh chemicals, launderings for the life of the mop and abuse when headband is used as a scrubber.
- Looped-end construction and fan-tail design allows for maximum floor coverage while eliminating tangling and fraying.

- All mops are individually poly-bagged.
- Available in narrow band (4.3 cm/ 1.75 in) and wide band (12.6 cm/ 5 in).

### Recommended frames:

- Snap-N-Go
- Jaw Breaker

Old Product Code	NEW Code	Product Description - <b>Wide Band</b>	Size	Pack	Application
MP4PSSLW	134859	Sentrex Looper, blue mesh, 6 row stitched, wide band	Small	12	  
MP4PSMLW	134856	Sentrex Looper, blue mesh, 6 row stitched, wide band	Medium	12	  
MP4PSLLW	134852	Sentrex Looper, blue mesh, 6 row stitched, wide band	Large	12	  
MP4PSXLW	134861	Sentrex Looper, blue mesh, 6 row stitched, wide band	XLarge	12	  

## Winger™ – Looped End Mop



### The economical alternative – cost effective colour coordination!

- Our Winger line of looped end mops are manufactured with many of the same quality features and benefits as our top-of-the-line Looper mops without the added cost.
- The Winger line is ideal for the institutional and food service industry.
- Superior strength and absorbency.
- Looped-end construction and fan-tail design allows for maximum floor coverage while eliminating tangling and fraying.
- All mops are individually poly-bagged.
- Avoid cross-contamination with colour coded mops.
  - Available in narrow band (4.3 cm/ 1.75 in) and wide band (12.6 cm/ 5 in).



### Recommended frame:

#### Narrow Band



























- Snap-N-Go
- Quick Change

### Recommended frame:

#### Wide Band

- Snap-N-Go
- Jaw Breaker

BL GR OR  
 PLEASE SPECIFY COLOUR WHEN ORDERING.

Old Product Code	NEW Code	Product Description - <b>Narrow Band</b>	Size	Pack	Application
WINGERS	135050	Winger, looped, 4 row stitched, narrow band – blue	Small	12	  
WINGER-S-GR	135051	Winger, looped, 4 row stitched, narrow band – green	Small	12	  
WINGER-S-OR	135052	Winger, looped, 4 row stitched, narrow band – orange	Small	12	  
WINGER-M	135043	Winger, looped, 4 row stitched, narrow band – blue	Medium	12	  
WINGER-M-GR	135044	Winger, looped, 4 row stitched, narrow band – green	Medium	12	  
WINGER-M-OR	135045	Winger, looped, 4 row stitched, narrow band – orange	Medium	12	  
WINGER-L	135034	Winger, looped, 4 row stitched, narrow band – blue	Large	12	  
WINGER-L-GR	135035	Winger, looped, 4 row stitched, narrow band – green	Large	12	  
WINGER-L-OR	135036	Winger, looped, 4 row stitched, narrow band – orange	Large	12	  

Old Product Code	NEW Code	Product Description - <b>Wide Band</b>	Size	Pack	Application
WINGER-SW	135053	Winger, looped, 6 row stitched, wide band – blue	Small	12	  
WINGER-SW-GR	135054	Winger, looped, 6 row stitched, wide band – green	Small	12	  
WINGER-SW-OR	135056	Winger, looped, 6 row stitched, wide band – orange	Small	12	  
WINGER-MWB	131613	Winger, looped, 6 row stitched, wide band – blue	Medium	12	  
WINGER-MWB-GR	135046	Winger, looped, 6 row stitched, wide band – green	Medium	12	  
WINGER-MWB-OR	135048	Winger, looped, 6 row stitched, wide band – orange	Medium	12	  
WINGER-LWB	135037	Winger, looped, 6 row stitched, wide band – blue	Large	12	  
WINGER-LWB-GR	135038	Winger, looped, 6 row stitched, wide band – green	Large	12	  
WINGER-LWB-OR	135040	Winger, looped, 6 row stitched, wide band – orange	Large	12	  

## ValueLine – Looped End Mop



- Looped-end construction and fan-tail design allows for maximum floor coverage while eliminating tangling and fraying.
- Economically priced with the ability to launder.
- Colour coded (Blue, Green, Orange)
- Blended cotton and synthetic yarn
- Ideal when a price sensitive, reasonable quality mop is required.
- Available in narrow band (4.3 cm/ 1.75 in) and wide band (12.6 cm/ 5 in).
- All mops are individually poly-bagged.

**Recommended frame:**  
**Narrow Band**

- Snap-N-Go
- Quick Change

**Recommended frame:**  
**Wide Band**

- Snap-N-Go
- Jaw Breaker

BL GR OR  
PLEASE SPECIFY COLOUR WHEN ORDERING.

Old Product Code	NEW Code	Product Description - Wide Band	Size	Pack	Application
MPLMSWBL-VL	136295	ValueLine looped mop, wide band – blue	Small	12	
MPLMSWGR-VL	136301	ValueLine looped mop, wide band – green	Small	12	
MPLMSWOR-VL	136307	ValueLine looped mop, wide band – orange	Small	12	
MPLMMWBL-VL	136293	ValueLine looped mop, wide band – blue	Medium	12	
MPLMMWGR-VL	136300	ValueLine looped mop, wide band – green	Medium	12	
MPLMMWOR-VL	136306	ValueLine looped mop, wide band – orange	Medium	12	
MPLMLWBL-VL	136291	ValueLine looped mop, wide band – blue	Large	12	
MPLMLWGR-VL	136298	ValueLine looped mop, wide band – green	Large	12	
MPLMLWOR-VL	136304	ValueLine looped mop, wide band – orange	Large	12	
MPLMXLWBL-VL	136297	ValueLine looped mop, wide band – blue	X - Large	12	
MPLMXLWGR-VL	136303	ValueLine looped mop, wide band – green	X - Large	12	
MPLMXLWOR-VL	136309	ValueLine looped mop, wide band – orange	X - Large	12	

Old Product Code	NEW Code	Product Description - Narrow Band	Size	Pack	Application
MPLMSBL-VL	136294	ValueLine looped mop, narrow band – blue	Small	12	
MPLMSGR-VL	136219	ValueLine looped mop, narrow band – green	Small	12	
MPLMSOR-VL	136143	ValueLine looped mop, narrow band – orange	Small	12	
MPLMMBL-VL	136292	ValueLine looped mop, narrow band – blue	Medium	12	
MPLMMGR-VL	136299	ValueLine looped mop, narrow band – green	Medium	12	
MPLMMOR-VL	136305	ValueLine looped mop, narrow band – orange	Medium	12	
MPLMLBL-VL	136290	ValueLine looped mop, narrow band – blue	Large	12	
MPLMLGR-VL	136218	ValueLine looped mop, narrow band – green	Large	12	
MPLMLOR-VL	136249	ValueLine looped mop, narrow band – orange	Large	12	
MPLMXLBL-VL	136296	ValueLine looped mop, narrow band – blue	X - Large	12	
MPLMXLGR-VL	136302	ValueLine looped mop, narrow band – green	X - Large	12	
MPLMXLOR-VL	136308	ValueLine looped mop, narrow band – orange	X - Large	12	



## MicroEco Cut End Mop™















Our MicroEco™ Cut End Mop is just another step in helping preserve our natural resources as it prevents thousands of bottles from becoming landfill waste. Together, we can all commit in doing our part to protecting the environment.

This unique 4 ply yarn is manufactured from a combination of 2 strands of Microfiber yarn and 2 strands of Green PET synthetic fibers derived from plastic bottles.

- All mops are individually poly-bagged.
- Available in narrow band (4.3 cm/ 1.75 in).

**Recommended frame:**  
**Narrow Band** – Snap-N-Go, Quick Change

































Old Product Code	NEW Code	Product Description - <b>Narrow Band</b>	Size	Pack	Application
CMN1202	134518	MicroEco cut end mop, narrow band	350 g/ 12 oz	12	  
CMN1602	134519	MicroEco cut end mop, narrow band	450 g/ 16 oz	12	  
CMN2002	134520	MicroEco cut end mop, narrow band	550 g/ 20 oz	12	  
CMN2402	134521	MicroEco cut end mop, narrow band	650 g/24 oz	12	  
CMN3202	134522	MicroEco cut end mop, narrow band	850 g/ 32 oz	12	  



## Sentrex™ – Cut End Mop

- Ideal for rugged cleaning on rough surfaces and high traffic areas.
- Made from a highly durable synthetic/nylon blended yarn with superior tensile strength properties – can be used for floor finishing and waxing.
- Delivers high absorbency and can withstand repeated laundering without linting.
- Heavy duty poly coated headband mesh withstands harsh chemicals, laundering for the life of the mop and abuse when headband is used as a scrubber.
- Available in narrow band (4.3 cm/ 1.75 in) and wide band (12.6 cm/ 5 in).
- Select sizes also available with bags.

**Recommended frame:**  
**Narrow Band** – Snap-N-Go, Quick Change  
**Wide Band** – Snap-N-Go, Jaw Breaker

Old Product Code	NEW Code	Product Description - <b>Narrow Band</b>	Size	Pack	Application
MP4PS12	134827	Sentrex mop, 4 row stitched, narrow band	350 g/ 12 oz	12	  
MP4PS12B	134828	Sentrex mop, 4 row stitched, narrow band – bagged	350 g/ 12 oz	12	  
MP4PS16	134830	Sentrex mop, 4 row stitched, narrow band	450 g/ 16 oz	12	  
MP4PS16B	134831	Sentrex mop, 4 row stitched, narrow band – bagged	450 g/ 16 oz	12	  
MP4PS20	134836	Sentrex mop, 4 row stitched, narrow band	550 g/ 20 oz	12	  
MP4PS20B	134837	Sentrex mop, 4 row stitched, narrow band – bagged	550 g/ 20 oz	12	  
MP4PS24	134841	Sentrex mop, 4 row stitched, narrow band	650 g/ 24 oz	12	  
MP4PS24B	134842	Sentrex mop, 4 row stitched, narrow band – bagged	650 g/ 24 oz	12	  
MP4PS32	134847	Sentrex mop, 4 row stitched, narrow band	850 g/ 32 oz	12	  
MP4PS32B	134848	Sentrex mop, 4 row stitched, narrow band – bagged	850 g/ 32 oz	12	  

Old Product Code	NEW Code	Product Description - <b>Wide Band</b>	Size	Pack	Application
MP4PS12WB	134829	Sentrex mop, 6 row stitched, wide band	350 g/ 12 oz	12	  
MP4PS16WB	134833	Sentrex mop, 6 row stitched, wide band	450 g/ 16 oz	12	  
MP4PS16WB B	134834	Sentrex mop, 6 row stitched, wide band – bagged	450 g/ 16 oz	12	  
MP4PS20WB	134839	Sentrex mop, 6 row stitched, wide band	550 g/ 20 oz	12	  
MP4PS24WB	134845	Sentrex mop, 6 row stitched, wide band	650 g/ 24 oz	12	  
MP4PS32WB	134849	Sentrex mop, 6 row stitched, wide band	850 g/ 32 oz	12	  



## Zinger™ – Cut End Wet Mop

- Zinger™ is manufactured with a unique blend of yarns that are superior to your conventional cut-end mops.
- Superior strength and absorbency.
- All mops are individually poly-bagged.
- Available in narrow band (4.3 cm/ 1.75 in).

**Recommended frame:**  
Snap-N-Go, Quick Change

Old Product Code	NEW Code	Product Description - Narrow Band	Size	Pack	Application
ZINGER-16	136325	Zinger, cut end, 4 row stitched, narrow band	16 oz/ 450 g	12	  
ZINGER-20	136326	Zinger, cut end, 4 row stitched, narrow band	20 oz/ 550 g	12	  
ZINGER-24	136327	Zinger, cut end, 4 row stitched, narrow band	24 oz/ 650 g	12	  
ZINGER-32	136328	Zinger, cut end, 4 row stitched, narrow band	32 oz/ 850 g	12	  



## ValueLine – Cut End – Synthetic

- Synthetic fiber allows for a longer lifespan
- Economically priced.
- Ideal when a price sensitive, reasonable quality mop is required.
- Available in narrow band (4.3 cm/ 1.75 in)
- All mops are individually poly-bagged.

**Recommended frame:**  
Snap-N-Go, Quick Change

Old Product Code	NEW Code	Product Description - Narrow Band	Size	Pack	Application
MP4PS16-VL	136286	ValueLine cut end mop, synthetic, 4 row stitched, narrow band	450 g/ 16 oz	12	  
MP4PS20-VL	136287	ValueLine cut end mop, synthetic, 4 row stitched, narrow band	550 g/ 20 oz	12	  
MP4PS24-VL	136288	ValueLine cut end mop, synthetic, 4 row stitched, narrow band	650 g/ 24 oz	12	  
MP4PS32-VL	136289	ValueLine cut end mop, synthetic, 4 row stitched, narrow band	850 g/ 32 oz	12	  



## ValueLine – Cut End – Cotton

- Economically priced.
- Ideal when a price sensitive, reasonable quality mop is required.
- Rugged cleaning in high traffic areas
- Available in narrow band (4.3 cm/ 1.75 in)
- All mops are individually poly-bagged.

**Recommended frame:**  
Snap-N-Go, Quick Change

Old Product Code	NEW Code	Product Description - Narrow Band	Size	Pack	Application
MP3P16-VL	136181	ValueLine mop, cut end, 2 row stitched, narrow band	450 g/ 16 oz	12	  
MP3P20-VL	136182	ValueLine mop, cut end, 2 row stitched, narrow band	550 g/ 20 oz	12	  
MP3P24-VL	136183	ValueLine mop, cut end, 2 row stitched, narrow band	650 g/ 24 oz	12	  
MP3P32-VL	136184	ValueLine mop, cut end, 2 row stitched, narrow band	850 g/ 32 oz	12	  



## C-Pro™ – Cut End Cotton Wet Mop

































- Cotton mops are made with a durable cotton yarn and are available in a looped fan tail design
- These mops deliver both high absorbency and superior durability
- Rugged cleaning in high traffic areas.
- Select sizes also available with bags.

### Recommended frame: Narrow Band

- Snap-N-Go
- Quick Change

### Recommended frame: Wide Band

- Snap-N-Go
- Jaw Breaker

Old Product Code	NEW Code	Product Description -	Size	Pack	Application
MP3P12	134807	C-Pro 4 row stitched, narrow band	350 g/ 12 oz	12	  
MP3P12B	134808	C-Pro 4 row stitched, narrow band – bagged	350 g/ 12 oz	12	  
MP3P16	134809	C-Pro 4 row stitched, narrow band	450 g/ 16 oz	12	  
MP3P16B	134810	C-Pro 4 row stitched, narrow band – bagged	450 g/ 16 oz	12	  
MP3P20	134813	C-Pro 4 row stitched, narrow band	550 g/ 20 oz	12	  
MP3P20B	134814	C-Pro 4 row stitched, narrow band – bagged	550 g/ 20 oz	12	  
MP3P24	134818	C-Pro 4 row stitched, narrow band	650 g/ 24 oz	12	  
MP3P24B	134819	C-Pro 4 row stitched, narrow band – bagged	650 g/ 24 oz	12	  
MP3P32	134823	C-Pro 4 row stitched, narrow band	850 g/ 32 oz	12	  
MP3P32B	134824	C-Pro 4 row stitched, narrow band – bagged	850 g/ 32 oz	12	  





Old Product Code	NEW Code	Product Description - Wide Band	Size	Pack	Application
MP3P16WB	134812	C-Pro 6 row stitched, wide band	450 g/ 16 oz	12	  
MP3P20WB	134817	C-Pro 6 row stitched, wide band	550 g/ 20 oz	12	  
MP3P24WB	134822	C-Pro 6 row stitched, wide band	650 g/ 24 oz	12	  
MP3P32WB	134826	C-Pro 6 row stitched, wide band	850 g/ 32 oz	12	  

## Sentrex Fantail™ – Cut End Wet Mop



- Ideal for rugged cleaning on rough surfaces and high traffic areas.
- Made from a highly durable synthetic/ rayon blended yarn with superior tensile strength properties.
- Delivers high absorbency and can withstand repeated laundering without linting.
- Heavy duty poly coated headband mesh withstands harsh chemicals, laundings for the life of the mop and abuse when headband is used as a scrubber.
- Fan-tail design allows for maximum floor coverage while eliminating tangling.
- Available in narrow band (4.3 cm/ 1.75 in).

**Recommended frame:**  
Snap-N-Go, Quick Change

Old Product Code	NEW Code	Product Description - Narrow Band	Size	Pack	Application
MP4PS20FT	134838	Sentrex mop, fan tail, 4 row stitched	550 g/ 20 oz	12	  
MP4PS24FT	134843	Sentrex mop, fan tail, 4 row stitched	650 g/ 24 oz	12	  



## C-Pro™ – Cotton Fan Tail Wet Mop

- Made with a cotton yarn with excellent water absorption and retention properties.
- Ideal for floor drying and general mopping.
- Fan-tail design allows for maximum floor coverage while eliminating tangling.
- Heavy duty poly coated headband mesh withstands harsh chemicals, launderings for the life of the mop and abuse when headband is used as a scrubber.
- Available in narrow band (4.3 cm/ 1.75 in).



**Recommended frame:**  
Snap-N-Go, Quick Change

Old Product Code	NEW Code	Product Description - Narrow Band	Size	Pack	Application
MP3P20FT	134816	C-Pro mop, fan tail, 2 row stitched	550 g/ 20 oz	12	  
MP3P24FTB	134821	C-Pro mop, fan tail, 2 row stitched – bagged	650 g/ 24 oz	12	  



## Promop Combo

- The Promop Combo is a value pack – C-Pro™ Cotton Cut End Wet Mop and Snap-N-Go™ Mop Handle.
- Provides all the benefits of our C-Pro™ cut end mops – superior water absorption and retention properties that are ideal for floor drying and general mopping.
- Heavy duty poly coated headband mesh withstands harsh chemicals, launderings for the life of the mop and abuse when headband is used as a scrubber.
- All mops are individually poly-bagged.

Old Product Code	NEW Code	Product Description - Narrow Band	Size	Pack	Application
MP5000CT	134863	ProMop and Snap-n-Go Blue Handle Complete	650 g / 24 oz	6	  







## Silky™ – Looped End Mop

### The ultimate mop in floor finishing

- Our lint free finishing mop will leave your floors streak free and with approximately 25% more shine due to its unique lint free yarn.
- Narrow band looped end construction gives Silky a longer life and allows mop to cover a larger floor area – leaving more finish on floor.

- Available in narrow band (4.3 cm/ 1.75 in).
- All mops are individually poly-bagged.

**Recommended frame:**  
Snap-N-Go, Quick Change

Old Product Code	NEW Code	Product Description - Narrow Band	Size	Pack	Application
FFSILKY16	134615	Lint free nylon floor mop – narrow band	16 oz/450 g	12	  
FFSILKY20	134616	Lint free nylon floor mop – narrow band	20 oz/550 g	12	  



## Super Waxer™ Finishing Mop



### Looped end candy stripe





- Ideal when frequently applying floor finish.
- Heavy duty poly coated headband mesh withstands harsh chemicals, launderings for the life of the mop and abuse when headband is used as a scrubber.
- Specially blended yarn designed for high absorbency while allowing for quick release of floor finish.
- Tightly twisted yarn increases durability, eliminates linting and streaking.
- All mops are individually poly-bagged.

### Recommended frame:

**Narrow Band** – Snap-N-Go, Quick Change

**Wide Band** – Snap-N-Go, Jaw Breaker

Old Product Code	NEW Code	Product Description - <b>Narrow Band</b>	Size	Pack	Application
MPLMCSS	134870	Super Waxer, narrow band	Small	12	  
MPLMCSM	134867	Super Waxer, narrow band	Medium	12	  
MPLMCSL	134864	Super Waxer, narrow band	Large	12	  

Old Product Code	NEW Code	Product Description - <b>Wide Band</b>	Size	Pack	Application
MPLMCSMWB	134869	Super Waxer, wide band	Medium	12	  
MPLMCSLWB	134866	Super Waxer, wide band	Large	12	  



## Ruff-T – Looped End Mop

- Constructed of specially woven strands, Ruff-T absorbs twice as much liquid as conventional mops making Ruff-T an ideal mop for non-slip, non-skid surfaces.
- Our Ruff-T looped mop stands up to rough floor surfaces such as stone, terrazzo, concrete and other textured surfaces.
- Ruff-T is an excellent mop for the healthcare and food service industry as well as general maintenance use.
- Available in wide band only
- All mops are individually poly-bagged.
- Available in wide band (12.6 cm/ 5 in).

### Recommended frame:

Snap-N-Go, Jaw Breaker

Old Product Code	NEW Code	Product Description - <b>Wide Band</b>	Size	Pack	Application
ST24WB	131609	Ruff-T rough service mop	Large	12	  



## Laundry Net

- Polyester mesh bag with drawstring locking closure.
- A necessary accessory for laundering wet mops and dust mops to avoid tangling.

Old Product Code	NEW Code	Product Description	Size	Pack	Application
MILN1020	135337	Laundry net – white drawstring, lock closures	61 x 91 cm/ 24 x 36 in	1	  

## Detachable Yacht Mops



### Loopy Looped End

- Made of a blue rayon/synthetic blended yarn that is durable.
- Ideal for hard to reach areas in general building, nursing homes, hospitals, and restaurants.
- The detachable mop head allows for machine washing.
- Looped End construction and fan-tail design allows for maximum floor coverage while eliminating tangling and fraying.
- Can be used with a 48 inch handle (FH348M / 135386) or any 15/16 inch threaded handle
- All mops are individually poly-bagged.

Old Product Code	NEW Code	Product Description	Size	Pack	Application
YM200	135059	Yacht mop, detachable, looped – refill only	275 g/ 10 oz	12	  



### Loopy Cut End









- Our Cut End is made of a white rayon/synthetic blended yarn and is an economical alternative to Loopy.
- Ideal for hard to reach areas in nursing homes, hospitals, and restaurants.
- The detachable mop head allows for machine washing.
- All mops are individually poly-bagged and can be used with our Threaded Handle (FH348M / 135386).
- All mops are individually poly-bagged.

Old Product Code	NEW Code	Product Description	Size	Pack	Application
YMDY10R	135060	Yacht mop, detachable, cut end – refill only	275 g/ 10 oz	12	  



### Synthetic Yacht Mops

























- Made of a durable and absorbent synthetic/rayon blended yarn.
- Ideal as an all purpose mop in hard to reach areas.
- These mops are securely wire bounded to a 137 cm/ 54 inch wood handle.
- All mops are individually poly-bagged.

Old Product Code	NEW Code	Product Description	Size	Pack	Application
YMHY10SYNB	135062	Yacht mop, synthetic, with wood handle and poly bag	275 g/ 10 oz	12	  
YMHY12SYNB	135064	Yacht mop, synthetic, with wood handle and poly bag	350 g/ 12 oz	12	  
YMHY16SYNB	135066	Yacht mop, synthetic, with wood handle and poly bag	450 g/ 16 oz	12	  



## Cotton Yacht Mops

- Made from a cotton yarn with excellent water absorption and retention properties.
- Ideal for floor drying and general mopping in hard to reach areas.
- These mops are securely wire bounded to your choice of a metal or wood handle.
- All yacht mops can be easily wrung in a downpress wringer when used together with a downpress universal wringer insert (FM1232-IN / 519765).
- Yacht mops can also be used with buckets and cone wringers.
- All mops are individually poly-bagged.

Old Product Code	NEW Code	Product Description	Size	Pack	Application
YMY8B	135072	Yacht mop, Cotton, with 48" metal handle – bagged	225 g/ 8 oz	12	  
YMY10B	135069	Yacht mop, Cotton, with 48" metal handle – bagged	275 g/ 10 oz	12	  
YMY12B	135070	Yacht mop, Cotton, with 48" metal handle – bagged	350 g/ 12 oz	12	  
YMY16B	135071	Yacht mop, Cotton, with 48" metal handle – bagged	450 g/ 16 oz	12	  
YMHY8B	135068	Yacht mop, Cotton, with 54" wood handle – bagged	225 g/ 8 oz	12	  
YMHY10B	135061	Yacht mop, Cotton, with 54" wood handle – bagged	275 g/ 10 oz	12	  
YMHY12B	135063	Yacht mop, Cotton, with 54" wood handle – bagged	350 g/ 12 oz	12	  
YMHY16B	135065	Yacht mop, Cotton, with 54" wood handle – bagged	450 g/ 16 oz	12	  
YMHY20B	135067	Yacht mop, Cotton, with 54" wood handle – bagged	550 g/ 20 oz	12	  









## The Vileda Bee Mop Classic

- Angled head makes thorough cleaning effortless.
- The Super Dry Sponge allows your floors to dry three times faster than ordinary sponge mops.
- Light and easy to use.
- Easy to wring with ergonomic soft grip handle.
- Keeps your hands dry.
- Efficient on all types of floors: tiles, linoleum and hardwood.

### Refill

- The Super Dry Sponge allows your floors to dry three times faster than ordinary sponge mops.
- Easy to change refill.
- Efficient on all types of floors: tiles, linoleum and hardwood.



Old Product Code	NEW Code	Product Description	Size	Pack	Application
SM117600	126595	Vileda Bee Mop Classic	25.4 cm/ 10 in	6	  
SM117613	117612	Vileda Bee Mop Classic – refill	25.4 cm/ 10 in	6	  



## Snap-N-Go™ Mop Handles

Our lightweight mop handle is made of re-enforced high impact plastic and is designed to accommodate any size mop – both narrow and wide band. This mop handle features a unique lever which gives a new meaning to hands free. Simply snap lever open to insert new mop head or discard soiled mop head. Ideal for the most sanitary areas.

- 152 cm / 60 inch handle – overall length: 160 cm / 63 inch
- Colour coding grip to reduce cross contamination
- Hang-up on grip handle makes it simple for drying and storage
- Accommodates mops up to 7 1/2" in width
- Fits both narrow and wide band mops
- Conforms with foodservice standards
- **Lightweight, yet strong** – Composite properties maximized by advanced Pull-Winding process, ensuring maximum strength and ergonomics.
- **Colourful** – Standard colours are yellow, red, blue, and green



Unless specified, the Blue Colour Grip will be received. Applies to Fiberglass only.



Item	Old Product Code	NEW Code	Product Description - Fiberglass	Diameter	Size	Pack	Application
1	MH7000F	134751	Snap-n-Go Blue Fiberglass Handle	1 in	152.4 cm/ 60 in	12	
1	MH7000FG	136276	Snap-n-Go Green Fiberglass Handle	1 in	152.4 cm/ 60 in	12	
1	MH7000FR	136277	Snap-n-Go Red Fiberglass Handle	1 in	152.4 cm/ 60 in	12	
1	MH7000FY	136279	Snap-n-Go Yellow Fiberglass Handle	1 in	152.4 cm/ 60 in	12	
1	MH7000F-54	134752	Snap-n-Go Blue Fiberglass Handle	1 in	137.2 cm/ 54 in	12	
1	MH7000FG-54	136270	Snap-n-Go Green Fiberglass Handle	1 in	137.2 cm/ 54 in	12	
1	MH7000FR-54	136271	Snap-n-Go Red Fiberglass Handle	1 in	137.2 cm/ 54 in	12	
1	MH7000FY-54	136272	Snap-n-Go Yellow Fiberglass Handle	1 in	137.2 cm/ 54 in	12	



PLEASE SPECIFY COLOUR WHEN ORDERING.

Item	Old Product Code	NEW Code	Product Description - Wood	Diameter	Size	Pack	Application
2	MH7000W-54	134755	Snap-n-Go wood handle	1 1/8 in	137.2 cm/ 54 in	12	
2	MH7000W-60	134756	Snap-n-Go wood handle	1 1/8 in	152.4 cm/ 60 in	12	

Item	Old Product Code	NEW Code	Product Description - Metal	Diameter	Size	Pack	Application
3	MH7000M-54	134753	Snap-n-Go - blue metal handle	1 in	137.2 cm/ 54 in	12	
3	MH7000M-BL	134754	Snap-n-Go - blue metal handle	1 in	152.4 cm/ 60 in	12	

Item	Old Product Code	NEW Code	Product Description - Aluminum	Diameter	Size	Pack	Application
4	MH7000A	134750	Snap-n-Go aluminum handle	1 in	152.4 x 2.5 cm/ 60 x 1 in	12	

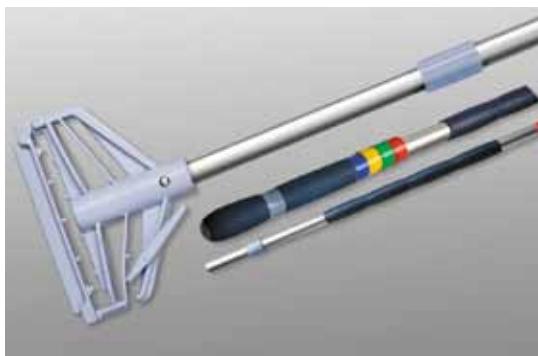

## Snap-N-Go™ Telescopic Handle

- Lightweight and extremely durable aluminum telescopic handle.
- Ergonomic centre grip and anti-slip handle grip.
- Excellent for workers on modified duties
- Conforms with foodservice standards
- Fits both narrow and wide band mops
- Expands from 100 to 180 cm/ 40 to 71 inches



Old Product Code	NEW Code	Product Description	Size	Pack	Application
MH7000EXT	131605	Snap-N-Go with telescopic handle and colour rings (BRYG)	100x 180 cm/ 40 x 71 in	1	



## Quick Change Mop Handle

- This economical quick change mop handle is designed for both narrow and wide band mops of any size. Available in 137 cm / 54 inch wood
- All metal parts are zinc plated to retard corrosion while wing nut and mop pressure plate are brass plated to eliminate rusting.
- Ideal for narrow band mops
- Overall length 157 cm / 62 inch

Old Product Code	NEW Code	Product Description	Diameter	Size	Pack	Application
MH145W	134746	Quick Change wood handle	1 1/8 in	2.86 x 137 x 18 cm/ 1.125 x 54 x 7 in	12	



## Jaw Breaker™ Plastic Handles

- Lock jaw allows for fast and easy release of mop by simply unscrewing the collar, no need to touch soiled mop.
- Features a lock collar attachment which allows for easy handle replacement.
- Available with choice of wood, fiberglass or metal handles.
- 152 cm / 60 inch handle – overall length: 168 cm / 66 inch
- Hang-up on grip handle makes it simple for drying and storage



- **Colourful** – Standard colours are yellow, red, blue, and green
- **Lightweight, yet strong** – Composite properties maximized by advanced Pull-Winding process, ensuring maximum strength and ergonomics.

Unless specified, the Blue Colour Grip will be received. Applies to Fiberglass only.

■ BL  
 ■ GR  
 ■ RD  
 ■ YE  
 PLEASE SPECIFY COLOUR WHEN ORDERING.



Old Product Code	NEW Code	Product Description	Diameter	Size	Pack	Application
MH160W	134749	Jaw Breaker - Wood handle	1 1/8 in	152 x 2.5 cm/ 60 x 1 in	12	
MH160M-60	134748	Jaw Breaker - Metal handle with plastic coating	1 1/8 in	152 x 2.5 cm/ 60 x 1 in	12	
MH160F	134747	Jaw Breaker Fiberglass handle - blue	1 in	152 x 2.5 cm/ 60 x 1 in	12	
MH160FG	138522	Jaw Breaker Fiberglass handle - green	1 in	152 x 2.5 cm/ 60 x 1 in	12	
MH160FR	138523	Jaw Breaker Fiberglass handle - red	1 in	152 x 2.5 cm/ 60 x 1 in	12	
MH160FY	138524	Jaw Breaker Fiberglass handle - yellow	1 in	152 x 2.5 cm/ 60 x 1 in	12	

# DUST MOPPING





## Dust Mopping



### Why is Dust Mopping so important?

The regular use of a dust mop will control dust which saves time and money while promoting a healthy environment. Routine dust removal will eliminate abrasive dust particles that ruin your floor and its finish. Dust mopping will protect your floors, help save you time and drastically reduce your labour cost for stripping and refinishing floors. Dust mops are an important factor to developing a floor care program. We offer quality dust mops in various sizes, designed for top performance.

Our complete line of mops can make your dust control program a success.

### Dustmops

All dust mops, whether cotton or Hi-Stat, are constructed from the highest quality yarns that are sewn onto a durable polyester backing.

Available in two styles, Tie-On or Break-Away ranging in lengths from 18" to 60". Every floor that is being dusted requires a dust mop specifically designed for that environment, in order to provide the best

possible performance. Environment, budget and preference will be the determining factors as to which type of dust mop is best suitable for the task at hand.

We manufacture varieties of high quality dust mops to assist in the efficient removal of dust and dirt.

All our dust mops are designed for high performance in the most demanding environments.

### Caring for your Dust Mop

1. At the end of each shift/usage, the dust mops should be shaken out, vacuumed or brushed completely, in order to remove the larger particles from the mop. If treatment is being used, it should be re-treated when necessary.
2. If the dust mop is clean, it should be stored upright in a clean/dry area, away from the wall and floor.
3. If the dust mop is soiled, it should be laundered. We recommend a laundry net be used. Cotton, Hi-Stat, G-Stat dust mops should be laundered separately.
4. Mops manufactured using synthetic yarn are better for laundering.

## Dust Mop Pocket Styles

### Tie-On



### Break-Away





## HiStat™ Dust Mop - Break Away





































**The ultimate dust mop.  
A must when you demand ultimate quality and value.**

- All our HiStat dust mops have the ability to remove dust without the need for expensive and potentially hazardous dust mop treatments.
- HiStat uses electrostatic properties to attract and hold dust particles.
- HiStat dust mops are manufactured from durable specially blended yarn that is sewn onto a durable polyester backing.
- The specially blended yarn allows dust mops to withstand heavy use and repeated commercial laundering with virtually no fraying, tangling, unravelling and linting.
- These mops feature much more yarn fill than competitive mops; therefore, increasing the ability to control dust.
- Use a Break Away frame with all Break Away mops



PLEASE SPECIFY COLOUR WHEN ORDERING.



Old Product Code	NEW Code	Product Description	Size	Pack	Application
DMBA518NB	134564	18" Hi Stat break away refill – blue	13 x 46 cm/ 5 x 18 in	10	  
DMBA518NG	134565	18" Hi Stat break away refill – green	13 x 46 cm/ 5 x 18 in	10	  
DMBA524NB	134568	24" Hi Stat break away refill – blue	13 x 91 cm/ 5 x 24 in	10	  
DMBA524NR	134570	24" Hi Stat break away refill – red	13 x 152 cm/ 5 x 24 in	10	  
DMBA536NB	134573	36" Hi Stat break away refill – blue	13 x 91 cm/ 5 x 36 in	10	  
DMBA536NG	134574	36" Hi Stat break away refill – green	13 x 91 cm/ 5 x 36 in	10	  
DMBA536NR	134575	36" Hi Stat break away refill – red	13 x 91 cm/ 5 x 36 in	10	  
DMBA548NB	134577	48" Hi Stat break away refill – blue	13 x 122 cm/ 5 x 48 in	5	  
DMBA548NG	134578	48" Hi Stat break away refill – green	13 x 122 cm/ 5 x 48 in	5	  
DMBA548NR	134579	48" Hi Stat break away refill – red	13 x 122 cm/ 5 x 48 in	5	  
DMBA560NB	134580	60" Hi Stat break away refill – blue	13 x 152 cm/ 5 x 60 in	5	  
DMBA560NG	134581	60" Hi Stat break away refill – green	13 x 152 cm/ 5 x 60 in	5	  



## Cotton Dust Mops - Break-Away

- Our quality cotton dust mops are absorbent and economical.
- These industrial standard dust mops are constructed of a four-ply high quality cotton yarn that is sewn onto a durable polyester backing.
- All cotton dust mops feature more yarn fill than competitive mops on the market which translates to even greater dust retention.
- Available in lengths from 46 to 152 cm / 18 to 48 inch.
- Ideal for schools, commercial, contractor markets or anywhere where price is an important criteria.
- **Use a Break Away frame with all Break Away mops**

Old Product Code	NEW Code	Product Description	Size	Pack	Application
DMBA518C	134563	18" Cotton break away refill	46 cm x 13 cm / 18 x 5 in	10	  
DMBA524C	134567	24" Cotton break away refill	61 x 13 cm/ 24 x 5 in	10	  
DMBA536C	134572	36" Cotton break away refill	91 x 13 cm/ 36 x 5 in	10	  
DMBA548C	134576	48" Cotton break away refill	122 x 13 cm/ 48 x 5 in	5	  

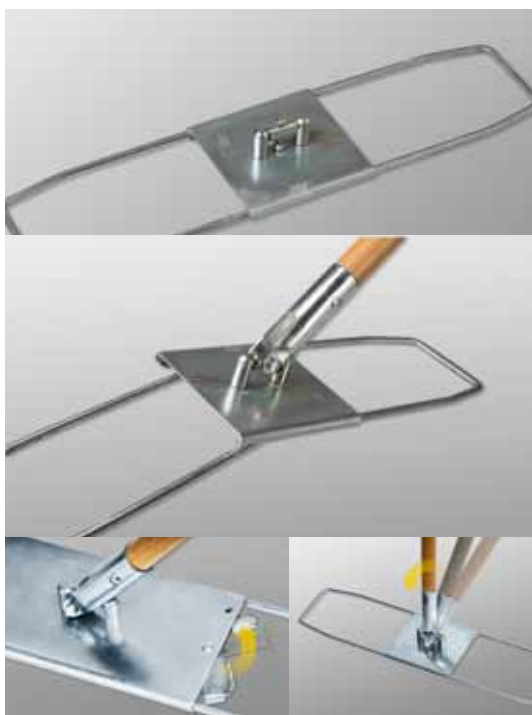

## Ezy Break-Away Frame And Handle

- Constructed of a heavy galvanized metal wire, the EZY Break-Away frame features a rotating locking lever that securely locks the frame when in use
- EZY Break-Away frames swivel 360° degrees at all angles to provide the most versatile, dust control tool
- Designed for repeated commercial use
- These heavy duty durable frames feature a unique handle connector that connects securely to the frame for a longer life and no breakages.
- Frames are available in lengths from 18" to 48" for the 5" Series Dust Mops

- The EZY Break-Away handle comes complete with a unique connector to fasten to the frame

Old Product Code	NEW Code	Product Description	Size	Pack	Application
DTEZ518F	519721	18" Ezy break-away dustmop frame	13 x 46 in/ 5 x 18 in	1	  
DTEZ524F	519722	24" Ezy break-away dustmop frame	13 x 61 in/ 5 x 24 in	1	  
DTEZ536F	519723	36" Ezy break-away dustmop frame	13 x 91 cm/ 5 x 36 in	1	  
DTEZ548F	519724	48" Ezy break-away dustmop frame	13 x 122 cm/ 5 x 48 in	1	  

Old Product Code	NEW Code	Product Description	Size	Pack	Application
DTEZ60	135352	Ezy break-away wood Handle	152 cm/ 60 in	1	  

## MicroEco Dust Mop - Tie-on



Go green... naturally, with our new MicroEco Dust Mop made of post-consumer PET plastic soda bottles and revolutionary Microfiber technology. The advantages of utilizing microfiber yarn are: minimized linting, high resistance to chemicals & disinfectants resulting in a mop that works.

Our MicroEco Mop is just another step in helping preserve our natural resources as it prevents thousands of bottles from becoming landfill waste. Together, we can all commit in doing our part to protect the environment.

This unique 4 ply yarn is manufactured from a combination of 2 strands of Microfiber yarn and 2 strands of Green PET synthetic fibers derived from plastic bottles.

- Use a dustmop frame with all Tie-on dust mops – See page 31

Old Product Code	NEW Code	Product Description	Size	Pack	Application
DM-ME5001	134586	24" MicroEco dust mop refill – Tie-on	61 x 13 cm/ 24 x 5 in	12	
DM-ME5002	134587	36" MicroEco dust mop refill – Tie-on	91 x 13 cm/ 36 x 5 in	12	
DM-ME5003	134588	48" MicroEco dust mop refill – Tie-on	122 x 13 cm/ 48 x 5 in	6	























































## HiStat™ Dust Mop - Tie-On

### The ultimate dust mop. A must when you demand ultimate quality and value.

- All of our HiStat dust mops have the ability to remove dust without the need for expensive and potentially hazardous dust mop treatments.
- HiStat uses electrostatic properties to attract and hold dust particles.
- Our HiStat dust mops are manufactured from durable specially blended yarn that is sewn onto a durable polyester backing.
- The specially blended yarn allows dust mops to withstand heavy use and repeated commercial laundering with virtually no fraying, tangling, unravelling and linting.
- These mops feature much more yarn fill than competitive mops; therefore, more yarn to control dust.

■ BL    ■ GR    ■ RD    ■ YE    PLEASE SPECIFY COLOUR WHEN ORDERING.



Old Product Code	NEW Code	Product Description	Size	Pack	Application
DM518NB	134532	18" Hi Stat tie-on refill – blue	13 x 46 cm/ 5 x 18 in	10	  
DM518NG	134533	18" Hi Stat tie-on refill – green	13 x 46 cm/ 5 x 18 in	10	  
DM518NR	134534	18" Hi Stat tie-on refill, red	13 x 46 cm/ 5 x 18 in	10	  
DM524NB	134538	24" Hi Stat tie-on refill – blue	13 x 61 cm/ 5 x 24 in	10	  
DM524NG	134539	24" Hi Stat tie-on refill – green	13 x 61 cm/ 5 x 24 in	10	  
DM524NR	134540	24" Hi Stat tie-on refill red	13 x 61 cm/ 5 x 24 in	10	  
DM524NY	134541	24" Hi Stat tie-on refill yellow	13 x 61 cm/ 5 x 24 in	10	  
DM536NB	134545	36" Hi Stat tie-on refill – blue	13 x 91 cm/ 5 x 36 in	10	  
DM536NG	134546	36" Hi Stat tie-on refill – green	13 x 91 cm/ 5 x 36 in	10	  
DM536NR	134547	36" Hi Stat tie-on refill – red	13 x 91 cm/ 5 x 36 in	10	  
DM536NY	134548	36" Hi Stat tie-on refill – yellow	13 x 91 cm/ 5 x 36 in	10	  
DM548NB	134553	48" Hi Stat tie-on refill – blue	13 x 122 cm/ 5 x 48 in	5	  
DM548NG	134554	48" Hi Stat tie-on refill – green	13 x 122 cm/ 5 x 48 in	5	  
DM548NR	134555	48" Hi Stat tie-on refill – red	13 x 122 cm/ 5 x 48 in	5	  
DM548NY	134556	48" Hi Stat tie-on refill – yellow	13 x 122 cm/ 5 x 48 in	5	  
DM560NB	134560	60" Hi Stat tie-on refill – blue	13 x 152 cm/ 5 x 60 in	5	  
DM560NG	134561	60" Hi Stat tie-on refill – green	13 x 152 cm/ 5 x 60 in	5	  
DM560NR	134562	60" Hi Stat tie-on refill – red	13 x 152 cm/ 5 x 60 in	5	  



## DynaPack™ Dust Mop Kit - Tie-on

- We have conveniently packaged our superior HiStat dust mop refill complete with frame and 152 cm / 60 in hardwood handle
- Frames and dust mops are 13 cm / 5 in wide in 61 – 122 cm / 24 – 48 in

Old Product Code	NEW Code	Product Description	Size	Pack	Application
DMDDMC24	134582	24" DynaPack™ combo kit – tie-on style	61 x 13 cm/ 24 x 5 in	1	
DMDDMC36	134583	36" DynaPack™ combo kit – tie-on style	91 x 13 cm/ 36 x 5 in	1	
DMDDMC48	134584	48" DynaPack™ combo kit – tie-on style	122 x 13 cm/ 48 x 5 in	1	



## G-Stat Dust Mops - Tie-on

- Specifically designed yarn for greater pickup of dust particles.
- Resists fraying and tangling even after prolonged use.
- Long wearing polyester backing with extra stitching to ensure longer life.
- The specially blended yarn allows dust mops to withstand heavy use and repeated commercial laundering with virtually no fraying, tangling, unravelling and linting.



**BL** **RD**  
 PLEASE SPECIFY COLOUR WHEN ORDERING.

Old Product Code	NEW Code	Product Description	Size	Pack	Application
DM518GB	134530	18" G-Stat tie-on refill – blue	13 x 46 cm/ 5 x 18 in	10	
DM518GR	134531	18" G-Stat tie-on refill – red	13 x 46 cm/ 5 x 18 in	10	
DM524GB	134536	24" G-Stat tie-on refill – blue	13 x 61 cm/ 5 x 24 in	10	
DM524GR	134537	24" G-Stat tie-on refill – red	13 x 61 cm/ 5 x 24 in	10	
DM536GB	134543	36" G-Stat tie-on refill – blue	13 x 91 cm/ 5 x 36 in	10	
DM536GR	134544	36" G-Stat tie-on refill – red	13 x 91 cm/ 5 x 36 in	10	
DM548GB	134550	48" G-Stat tie-on refill – blue	13 x 122 cm/ 5 x 48 in	5	
DM548GR	134552	48" G-Stat tie-on refill – red	13 x 122 cm/ 5 x 48 in	5	
DM560GB	134558	60" G-Stat tie-on refill – blue	13 x 152 cm/ 5 x 60 in	5	
DM560GR	134559	60" G-Stat tie-on refill – red	13 x 152 cm/ 5 x 60 in	5	



## Cotton Dust Mops - Tie-on

- A quality cotton dust mop that is absorbent and economical.
- These industrial standard dust mops are constructed of a four-ply high quality cotton yarn that is sewn onto a durable polyester backing.
- Our cotton dust mops feature much more yarn fill than competitive mops on the market which translates to even greater dust retention.
- Ideal for commercial, contractor markets or anywhere where price is an important criteria.

Old Product Code	NEW Code	Product Description	Size	Pack	Application
DM518C	134529	18" Cotton dust mops – tie-on	46 cm x 13 cm / 18 x 5 in	10	
DM524C	134535	24" Cotton dust mops – tie-on	61 x 13 cm/ 24 x 5 in	10	
DM536C	134542	36" Cotton dust mops – tie-on	91x13 cm/ 36 x 5 in	10	
DM548C	134549	48" Cotton dust mops – tie-on	122x13 cm/ 48 x 5 in	5	
DM560C	134557	60" Cotton dust mops – tie-on	152x13 cm/ 60 x 5 in	5	



## Clip-On Frame

- All of our frames are constructed of a galvanized metal wire.
- These durable industry standard frames feature a unique clip-on handle connecting system with no loose parts to be used with tie-on mops.
- All dust mop frames feature a 360° swivel which allows for easy manoeuvrability
- **Handles are sold separately.**

Old Product Code	NEW Code	Product Description	Size	Pack	Application
DTCO518F	519714	18" Clip-on frame only	46 cm x13 cm/ 18 x 5 in	1	
DTCO524F	519715	24" Clip-on frame only	61 x13 cm/ 24 x 5 in	1	
DTCO536F	519716	36" Clip-on frame only	91x13 cm/ 36 x 5 in	1	
DTCO548F	519717	48" Clip-on frame only	122x13 cm/ 48 x5 in	1	
DTCO560F	519718	60" Clip-on frame only	152x13 cm/ 60x5 in	1	



## Clip-on handle

- 152 cm / 60 inch lacquered wood handle features unique sliding pin that ensures quick, easy connection with frame.
- Lightweight but strong telescopic handle with colour clips (BRYG).
- Ergonomic centre grip and anti-slip handle grip
- Conforms with foodservice standards



Old Product Code	NEW Code	Product Description	Size	Pack	Application
DTCO60	135353	60" Clip-on connector and wood Handle	2.39 x 152 cm/ 15/16 x 60 in	1	
DTCO60-EXT	135389	60" Clip-on connector and telescopic Handle and colour rings (BRYG)	2.39 x 152 cm/ 15/16 x 60 in	1	

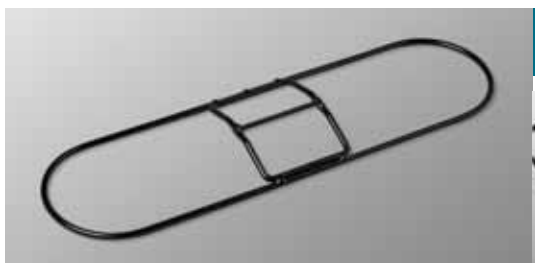

## Snap-On Frames



- Durable Snap-on frames are designed to be used with tie-on style dustmops

Old Product Code	NEW Code	Product Description	Size	Pack	Application
DTSN518F	519726	18" Snap-on dust mop – frame only	13 x 46 in/ 5x 18 in	1	
DTSN524F	519727	24" Snap-on dust mop – frame only	13 x 61 in/ 5 x 24 in	1	
DTSN536F	519728	36" Snap-on dust mop – frame only	13 x 91 cm/ 5 x 36 in	1	
DTSN548F	519729	48" Snap-on dust mop – frame only	13 x 122 cm/ 5 x 48 in	1	
DTSN560F	519730	60" Snap-on dust mop – frame only	13 x 152 cm/ 5 x 60 in	1	



## Snap-On Handle

- Handles rotate in all directions and can be locked with slider

Old Product Code	NEW Code	Product Description	Size	Pack	Application
DTSN60	135350	60" Snap-on Handle	2.5 x 152 cm/ 1 x 60 in	1	
DTSN60F	135349	60" Snap-on Fiberglass Handle	2.5 x 152 cm/ 1 x 60 in	1	



## Scissor Mop

- Ideal for gymnasiums, warehouses, hospitals, airports or any large open areas.
- Saves time by covering large areas in half the time of conventional dust mops with an open span of 193 cm / 76 inch.
- Center "V" design provides a collection point for heavy soil and trash.
- Scissor mop frames are constructed of a heavy duty metal. Handles fold to allow adjusting for various widths and enable easy passage through narrow areas. Can be closed for easy storage.
- Scissor mops are sold complete with two 97 cm / 38 inch launderable hi-stat refills.
- **Please order all three (3) components for a complete Scissor Mop unit**

Old Product Code	NEW Code	Product Description	Size	Pack	Application
2999F	519526	Scissor mop – frame only	193 cm / 76"	1	
2999H	519527	Scissor mop – handle only	193 cm / 76"	1	
2999R	134404	Scissor Mop Hi-Stat – blue refill – Set of 2 mops	97 cm / 38"	1	



## Household Dust Mop

- Ideal for small tight or hard to reach areas like offices, homes, retail shops and classrooms.
- Manufactured utilizing our superior G-Stat Blue yarn
- Conveniently packaged to include 121 cm / 48" frame and handle

Old Product Code	NEW Code	Product Description	Size	Pack	Application
DM1216	134525	Household dustmop complete		6	
DM1216F	134526	Household dust mop – frame only		1	
DM1216-FH378EX	134527	Household dustmop complete with frame and extension Handle	198 cm / 78 in	1	
DM1216R	134528	Household dust mop refill only – G-Stat, blue	31.8 x 40.6 cm / 12.5 x 16 in	5	



## Static Attack

Attack dry dust control system attracts more dirt and dust by creating a small electrical charge that attracts the debris into the thick fiber pile.

- Light trapezoid designed frame easily gets into corners
- A 360° swivel head allows for easier movement of frame
- Ideal for hospitals, nursing homes, offices and computer areas
- A pre-impregnated surface collects dust like a magnet
- Features a heavyweight viscose non-woven material impregnation for higher dirt collection.
- Can be used with our aluminum extension handle FH372EX-NT/ 135365 or our Vileda telescopic handle SW8357/119967



Old Product Code	NEW Code	Product Description	Size	Pack	Application
ST1200	134999	Static Attack – frame only	58.8 cm / 22 in	6	
ST1000	134998	Static Attack sheets	20 x 60 cm / 8 x 13.75 in	200	
CL101268	102505	Dustmop high performance cloth – yellow	34 x 60 cm / 9.5 x 23.6 in	50	



# UltraSpeed Floor Mopping System

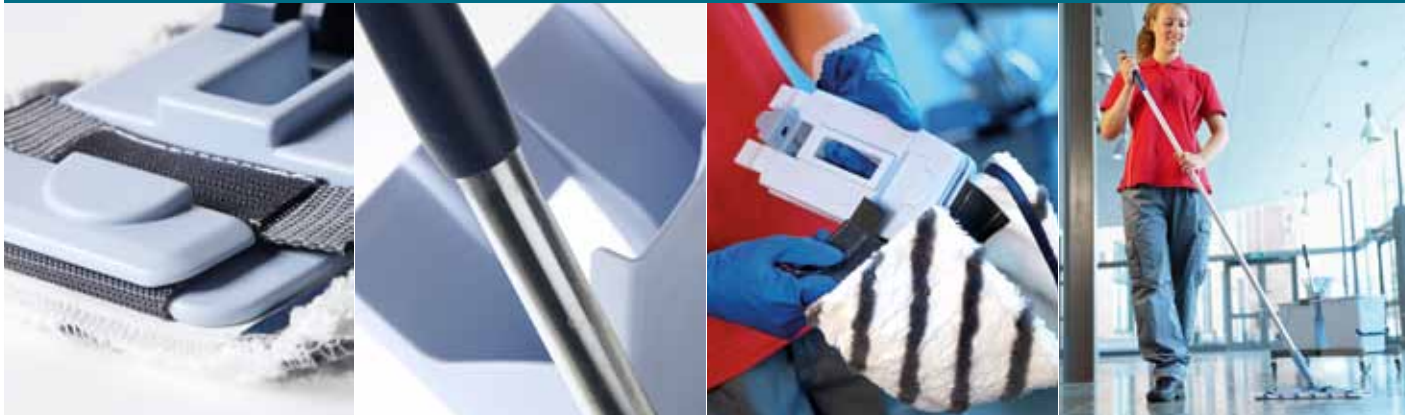

## One frame. All solutions.

The UltraSpeed System was developed to be simple to use, easy to clean difficult areas, offer maximum cleaning performance while significantly reducing mopping times. And all this at an affordable price. The result is a comprehensive floor cleaning system that sets new standards in usability, versatility, efficiency and ergonomics.

The benefits can be summarized in a single sentence: Performance made easy. Are you having problems with traditional mopping? UltraSpeed is the answer!

UltraSpeed is based around an innovative wringer that simplifies the wringing of flat mops and is available in your choice of systems from a 12 qt. kit for small areas through the Origo trolley system for large premises.

For a detailed video demonstration please visit our website: [vileda.com](http://vileda.com)



Traditional Mopping	VS. UltraSpeed
<p><b>Poor Hygiene:</b></p> <ul style="list-style-type: none"> <li>• Cotton mop heads suffer from poor appearance after several uses and can smell.</li> </ul>	<p><b>Hygienic:</b></p> <ul style="list-style-type: none"> <li>• Microfiber cleaning performance – 99.9% bacteria reduction</li> <li>• Microfiber mop pads machine washable up to 500 times</li> </ul>
<p><b>Low Performance:</b></p> <ul style="list-style-type: none"> <li>• Mop heads are hard to control making it easy to accidentally splash water on furniture and skirtings.</li> <li>• Cotton stores high levels of water in the mop head after wringing causing the mop head to aqua plane on the floor rather than clean it. The result is dirt being moved around the floor rather than removed from it.</li> </ul>	<p><b>High Performance:</b></p> <ul style="list-style-type: none"> <li>• 50% faster than conventional wet mopping over 50m<sup>2</sup> / 500 sq. ft.</li> <li>• 35% faster drying, floors back in use twice as fast.</li> <li>• 35% faster removal of stubborn dirt and stains.</li> <li>• Unique, changeable colour coding system</li> <li>• Special mop pad for use on safety floors</li> <li>• A variety of mops for different application areas</li> </ul>
<p><b>Difficult to Use:</b></p> <ul style="list-style-type: none"> <li>• Difficult to insert mop head into the bucket and press.</li> <li>• Cannot be used to clean walls, skirtings and staircases</li> <li>• Heavy</li> <li>• The machinery often involves complicated press mechanisms that can break and be strenuous.</li> <li>• Dust mopping is necessary before wet mopping</li> </ul>	<p><b>Easy to Use:</b></p> <ul style="list-style-type: none"> <li>• Easy to control. Flat mopping removes the chances of splashing other surfaces while cleaning.</li> <li>• Effectively cleans skirting boards, walls and staircases.</li> <li>• 50% lighter than conventional systems - ergonomic benefit</li> <li>• Chassis system allows buckets to be detached, reducing the weight when emptying and filling.</li> <li>• Eliminates the need for dust mopping.</li> </ul>



Staircases

## Versatile

Controlled cleaning with the flat mop frame, no splashing of other surfaces



Walls

Skirting's

Floors



## Colour Coded

Changeable colour coding system reduces SKUs and improves versatility

- To change colours just replace clip on the bucket
- Conforms with foodservice standards
  - All kits come complete with 8 clips (BRYG).
  - Extension handle features colour coded rings

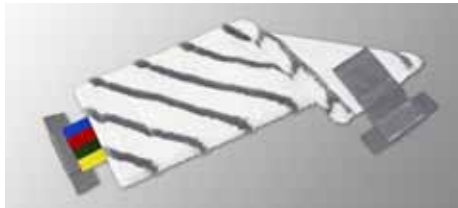

### UltraSpeed Mops

#### MicroPlus Mop - Universal (most versatile)

- Microfiber moppad for sealed and structured floors
- Power zone strips allow for scrubbing stubborn dirt
- For wet and moist mopping
- Washable up to 60° C /140° F

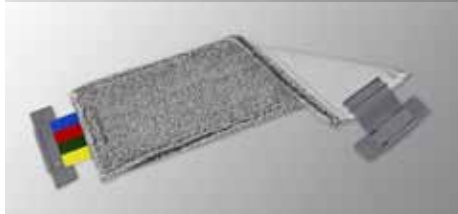

#### Micro Safe Mop

- Special mop for rough floors
- For wet scrubbing excellent in loosening stubborn dirt
- Washable up to 70° C /155° F



#### Trio Mop

- Different fibre types for absorbency and durability:
  - White zone:** Microfiber for high mechanical cleaning action with minimal chemical use
  - Grey zone:** First quality polyester provides low friction and high durability
  - Beige zone:** Blended polyester and viscose to provide absorbency
- Maximum temperature 95° C / 203° F



#### Micro Lite

- All purpose microfiber moppad for intensive cleaning
- Polyamide stripes to clean stubborn dirt very easily
- For wet and moist mopping and can be used for waxing
- All mops are washable up to 70° C /155° F
- Can be used for waxing



Old Product Code	NEW Code	Product Description	Size	Pack	Application
US114007	522101	UltraSpeed micro plus moppad	40 cm/ 16 in	1	
US114008	508248	UltraSpeed micro safe moppad	41 cm/ 16 in	1	
US114010	508249	UltraSpeed trio moppad	42 cm/ 16 in	1	
US114011	508250	UltraSpeed micro lite moppad	43 cm/ 16 in	1	



1



2



3

## UltraSpeed Combos

- Lightweight and robust buckets with ergonomic handles for carrying
- High efficiency patented gearless wringer with press handle
- Microfiber moppad for wet and moist mopping
- Lightweight durable 40 cm/16" break away frame can also be used with standard pocket mops
- Excellent for employees on light duties (50% lighter than traditional systems)
- Eliminate the need for dust mopping
- A variety of mops are available for different applications
- Conforms with foodservice standards
- Handle sold separately SW8357/119967



Item	Old Product Code	NEW Code	Product Description	Size	Pack	Application
1	US114985	114985	UltraSpeed Complete Starter Kit Combo	25 L/ 26 qt	1	
2	US113998	113998	UltraSpeed Combo with chassis/dolly	25 L/ 26 qt	1	
3	US116444	116444	UltraSpeed Double Bucket Combo with wringer, chassis/dolly and pushbar	25 L/ 26 qt	1	

## UltraSpeed Buckets



- 25 L / 26 Quart capacity
- Lightweight and robust bucket with ergonomic handles for carrying
- Unique spout lip guarantees precise pouring of water
- Coloured clips that can be changed to be used in a colour coding system



Old Product Code	NEW Code	Product Description	Size	Pack	Application
US114002	508243	UltraSpeed bucket with colour clips	25 L/ 26 qt	1	

## Telescopic Frame And Handle



- Light (425g/15oz.) durable 40 cm/16" break away frame
- Modern swivel joint with integrated ball catch. Easy to clean vertical surfaces
- Easy, fast rinsing / wringing of mops without removal from the frame
- Locking clip for attachment to handle
- Lightweight but strong telescopic handle with colour clips (BRYG).
- Ergonomic centre grip and anti-slip handle extends from 40" to 71"
- Conforms with foodservice standards



Old Product Code	NEW Code	Product Description	Size	Pack	Application
US113970	508095	UltraSpeed frame	40 cm/ 16 in	1	
SW8357	119967	Telescopic Handle with colour rings (BRYG)	100 x 180 cm / 40 x 71 in	1	



## UltraSpeed Funnel Wringer

- High efficiency patented gearless wringer with press handle for higher press performance
- Ergonomically designed grip allowing the user to apply extra pressure to get even better wringing result.
- Guided rib for supporting the insertion of the pad holder gives stability during wringing











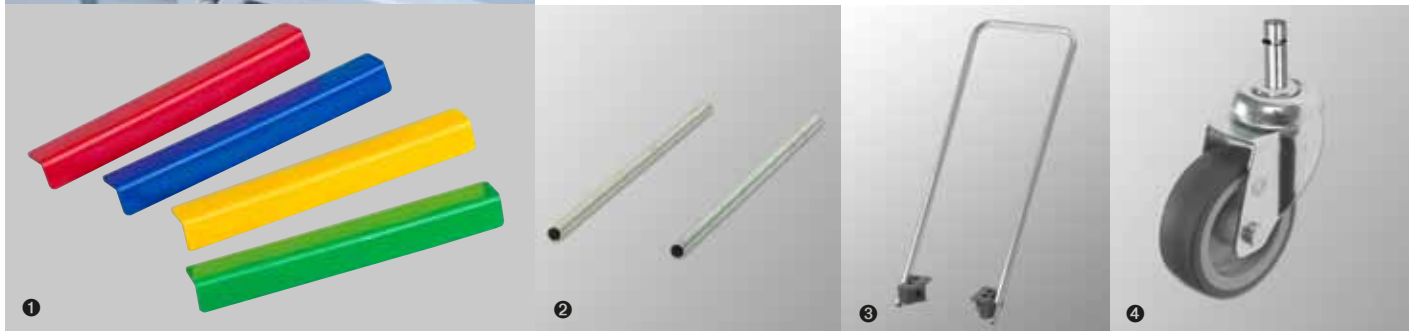













Old Product Code	NEW Code	Product Description	Size	Pack	Application
US113972	508097	UltraSpeed funnel press with handle	94.2 x 30.4 x 58.8 cm/ 37.09 x 11.97 x 23.15 in	1	  



## UltraSpeed accessories

- Use the below accessories to customize your UltraSpeed System



Item	Old Product Code	NEW Code	Product Description	Size	Pack	Application
1	US114003-BL	508239	UltraSpeed color clip – blue		1	  
1	509264	509264	UltraSpeed color clip – red		1	  
1	509265	509265	UltraSpeed color clip – green		1	  
1	509266	509266	UltraSpeed color clip – yellow		1	  
2	US114006	114397	UltraSpeed conversion kit – 2 metal bars + 1 metal clamp	50 x 17 x 6 cm/ 19.69 x 6.69 x 2.36 in	1	  
3	US115974	115974	UltraSpeed push bar with connectors	2 x 25 L/ 2 x 26 qt	1	  
4	US122341	512403	Castor for chassis	75 mm / 2.95 in	1	  

## UltraSpeed Mini



### Small in size. Big on Performance.

UltraSpeed Mini is the latest addition to the hugely successful UltraSpeed family. Created specifically to fulfil the requirements of all small area cleaning (107-322 sq ft/ 10-30 m<sup>2</sup>), UltraSpeed Mini combines the ergonomic, performance and hygiene benefits of the existing UltraSpeed range into a small, compact system.

### Twice as fast as traditional wet mopping at

- Cleaning small areas (215 sq ft/20 m<sup>2</sup>)
- Removing stubborn dirt
- Drying floors



### Suitable for more tasks than traditional wet mopping

UltraSpeed Mini allows you to do more than mop including:

- Walls and tile cleaning
- Skirting and staircases
- Safety floors (with SafeMop Pad)

### In more locations

The compact 10.5 qt/10L bucket and flat mop makes it ideal for offices, cafes, small retailers, restaurants, reception areas, hotel bedrooms/bathrooms, canteens, kitchens and toilets.



1



2













### MicroLite

- 90% PES microfibre for outstanding cleaning performance
- 10% PA fibre (grey) for stubborn dirt removal
- Cut off RBGY colour coded tags

### SafeMop

- Specially developed for use on rough and safety flooring
- Extra hard cut pile brush fibres
- Cut off RBGY colour coded tags



Item	Old Product Code	NEW Code	Product Description	Size	Pack	Application
	138841	138841	UltraSpeed Mini Starter Kit – Includes: 1 Bucket, 1 Wringer, 1 Frame, 1 MicroLite (pad), 1 SafeMop (pad)	154 x 35 x 33 cm / 60.63 x 13.78 x 12.99 in	1	  
	138844	138844	UltraSpeed Mini Telescopic Handle 81 x 143cm / 32 x 56"	81-142cm / 32-56 in	1	  
1	137573	137573	UltraSpeed Mini MicroLight Mop Pads	45.7 x 14 cm / 18 x 5.5 in	3	  
2	137574	137574	UltraSpeed Mini SafeMop Mop Pads	45.7 x 14 cm / 18 x 5.5 in	3	  

## The Swep System

Cut costs and defeat bacteria. All at the same time.



### Award-winning, cost efficient and complete system

Again – Swep from Vileda Professional is the market leading and most comprehensive solution, offering superior cost-in-use. The complete system includes everything needed for effective and time-saving cleaning – microfiber mops & cloths, frames, handles and accessories for dry, damp and wet cleaning.

Choose between Swep Classic or the new Swep Duo. The latter features double-sided high performance mops which allows up to double the cleaning area with just one mop. Perfect for larger patient rooms or corridors.

Swep Duo have won several international awards for outstanding functionality and design, such as iF product design and Red Dot award.



reddot design award  
winner 2006

## The Swep System

# Scientific tests prove the cleaning performance – up to 99.9 % bacteria removal

The BMA Laboratory in Bochum, Germany, carried out a test to determine the microbiological cleaning performance of Vileda Professional products. No chemicals or disinfectants were used in the test.

Bacteria strains were applied to an uncoated PVC floor material, which was then cleaned with Vileda Professional products that were moistened with a pre-defined amount of neutral cleaner.

The result was outstanding – up to 99,9 % removal of bacteria (*Pseudomonas aeruginosa* and *Staphylococcus aureus*).

Swept MicroPlus mop **99.92 %** bacteria removal

Swept MicroTech mop **99.66 %** bacteria removal

**Please contact one of our representatives to try this system.  
For a detailed video demonstration please visit our website:  
[vileda.com](http://vileda.com)**



## Enhanced for today's Healthcare environment

The Swep Microfiber cleaning system combines the latest materials and cleaning methods to remove the inadequacies of traditional systems.

### Reduced cross contamination/improved hygiene

After the cleaner finishes in one room/area they simply change the mop and place another pre-prepared mop on the frame for use in the next room/area. The soiled mop is then placed into a bag for laundering.

### Improved ergonomics – never wring a mop again!

A key objective in the development of the system was to reduce the effort required by the cleaner. Pre-prepared mops replace heavy buckets and wringers and the use of low-weight tools and materials reduces the muscular stresses on cleaning operatives.

### Chemical savings

The controlled pre-preparation method and mechanical action of the microfiber mops drastically reduce the amount of chemicals required in the cleaning process.



### 1000 wash guarantee

All mops in the Swep range are guaranteed to last 1000 wash cycles if correct washing protocols are followed – that's nearly three years' lifespan if laundered daily.

### Damp mopping – floors are back in use quicker

The controlled dosing system leaves each mop damp enough to remove dirt without leaving the floor wet, which results in floors getting back in use quicker.

### Pre-prepared mopping with equal dosing

Mops are centrally prepared before cleaning with the correct amount of water and chemical. This method removes the need for wringing or rinsing during the shift, reducing cleaning time.

The Swep dosing method ensures each mop is pre-dosed with an equal amount of water, guaranteeing effective cleaning from all the mops.

## Swep Classic Microfiber Cleaning System



### Swep Classic Mop Frame

- Lightweight, durable plastic frame, trapezoid shape
- Multi-directional swivel head for easy dirt removal – able to fit in narrow places
- Instruction of cleaning direction by arrow shown on top of frame
- Use with our SW8357/119967 Telescopic Handle



Old Product Code	NEW Code	Product Description	Size	Pack	Application
SW7581	114427	Swep high speed mop holder, plastic – grey	20 in/ 50.8 cm	1	



### Swep Classic MicroTech - Pocket

#### General Damp Mopping

- Patented fiber technology for a high durability and cleaning performance.
- Microfiber yarn cleans without the need of chemicals
- A universal mop for general damp mopping.
- High absorbency and 15% less friction when used damp
- Guaranteed washable up to 1000 times with hypochlorite. (if correct washing protocols are followed)



Old Product Code	NEW Code	Product Description	Size	Pack	Application
SW7586-50	508420	Swep Classic MicroTech – grey	20 in/ 50.8 cm	1	



### Swep Classic MicroCombi - Pocket

#### Intense Damp Cleaning

- Proven reduction in bacteria – Independent tests carried out by existing users show significant reductions in bacteria and dust. Data highlights reductions of outbreaks involving MRSA and C-Dif.
- New with strong cleaning stripes to reduce the friction
- For cleaning of open structured or absorbent floors
- Guaranteed washable up to 1000 times with hypochlorite. (if correct washing protocols are followed)



Old Product Code	NEW Code	Product Description	Size	Pack	Application
SW7594-50	507593	Swep Classic MicroCombi – grey	20 in/ 50.8 cm	1	



## Sweep Duo Microfiber Cleaning System

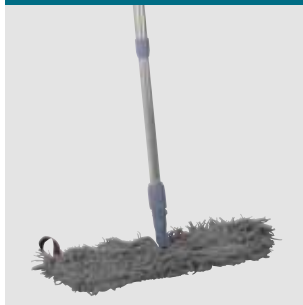

### Sweep Duo Safety Plus Mop



- Cut pile polyamide fibers offer superior scrubbing effect
- Extra strong fibers for long durability
- Low friction cleaning effect on “high friction” structured floors
- Perfect replacement of brushes for tiles and other textured surfaces
- 2 sided mop (Duo SafetyPlus) offers users the ability to scrub and pick up dirt with one mop



Old Product Code	NEW Code	Product Description	Size	Pack	Application
	512132	Sweep Duo Safety Plus mop refill	50.8 cm/ 20 in	1	

### Sweep Duo Double Sided Frame



- Lightweight and ergonomic durable plastic frame, trapezoid shape
- Multi-directional swivel head for easy dirt removal – able to fit in narrow places
- Instruction of cleaning direction by arrow shown on top of frame
- Use with our SW8357/119967 Telescopic Handle



Old Product Code	NEW Code	Product Description	Size	Pack	Application
SW111390	111391	Sweep Duo mop frame	50.8 cm/ 20 in	1	
SW8357	119967	Telescopic Handle with colour rings (BRYG)	100 x 180 cm / 40 x 71 in	1	

### Sweep Duo MicroTech Mop



- 100% Polyester
- High cleaning performance, low friction and maximum durability
- Commercial laundering up to 1000 times
- Highly resistant to chemicals
- Can be used damp or wet on most floors



Old Product Code	NEW Code	Product Description	Size	Pack	Application
SW121645	513686	Sweep Duo MicroTech mop refill	50.8 cm/ 20 in	1	

### Sweep Duo MicroPlus Mop



- 100% Microfiber
- Maximum Microfiber cleaning performance and long durability
- Commercial laundering up to 1000 times
- Open fiber structure with strong cleaning stripes for better gliding and greater particle pick-up



Old Product Code	NEW Code	Product Description	Size	Pack	Application
SW121646	513687	Sweep Duo MicroPlus mop refill	50.8 cm/ 20 in	1	

## Swept Duo mini - All Purpose Double Sided Flat Mopping System



This lightweight all purpose microfiber cleaning system offers comfort due to its easy gliding mops, low weight frame and highly ergonomic handle. This product can be used to clean walls, mirrors, bathroom stalls, blackboards, desks, and any other hard to reach soiled areas.

The Swept Duo mini is ideal for schools, cafeterias and general building applications. By using this product you will not only save time and money, you will be removing up to 99.92% of bacteria.



MicroPlus



MicroTech



**Launderable up to 1000 times!**

Old Product Code	NEW Code	Product Description	Size	Pack	Application
SW111384	111384	Telescopic Short Handle	50-90 cm/ 20-35 in	10	
SW116866	116867	Swept Duo Mini frame	35 cm / 14 in	1	
SW117052	510818	Swept Duo MicroTech Mop – Refer to previous page for specifications	35 cm/ 14 in	1	
SW117056	510822	Swept Duo MicroPlus Mop – Refer to Previous page for specifications	35 cm / 14 in	1	



## Mop / Cloth Preparation Box

Manual dosing sieve and preparation MopBox ensures correct dosing of mop pads.

### Prep MopBox

- To prepare mops or cloths for pre-paired cleaning
- Fits on the Origo trolley system – slides in/out to ensure easy pick-up of mops
- Can be stacked on top of each other and used with optional dolly
- Conforms with foodservice standards
- Colour coded clip included - 4 sets (RGBY)

### Sieve

- Fits on top of prep mop box for dosing mops on or off trolley
- Pierced with holes to ensure even dosing of mops



Old Product Code	NEW Code	Product Description	Pack	Application
SW120774	120806	Swep Pre MopBox colour clips	1	  
SW120779	120821	Swep Sieve for Pre MopBox	1	  
SW120780	120822	Swep Lid for Pre MopBox	1	  









## 6 L Origo Bucket

### High quality polypropylene buckets

- 6 L bucket to place on the top of the Origo Trolley
- To prepare mops or cloths for pre-paired cleaning
- Conforms with foodservice standards
- Colour coded clip included - 4 sets (RGBY)



Old Product Code	NEW Code	Product Description	Size	Pack	Application
SW120942	120943	Swep bucket with colour clips	6 L / 6.34 qt	1	  
125948	125948	Swep bucket 6 L lid	39.6 x 29.5 x .89 cm/ 15.59 x 11.61 x .35 in	12	  



## 25L Rectangular Bucket

### High quality polypropylene buckets

- 25 L Rectangular bucket to use with flat press included
- Conforms with foodservice standards
- Colour coded clip included - 4 sets (RGBY)

25 L bucket to be used with Duo Wringer Press



Old Product Code	NEW Code	Product Description	Size	Pack	Application
SW120944	120945	Origo rectangular long pail	25 L/ 26 qt	1	  







## MicroPad Cleaning System - Velcro Style



### MicroPad Floor Cleaning Tool

- The light weight aluminum frame has a trapezoid shape for corners. The hook and loop attachment will hold all pads securely. End caps are non-marking. Interlocking collar allows for most types of handles.
- A 360° degree swivel head allows for easier movement of frame.
- Can be used with our aluminum extension handle FH372EX-NT/ 135365 or our Vileda telescopic handle SW8357/119967



Old Product Code	NEW Code	Product Description	Size	Pack	Application
CL7400-16	135348	16" MicroPad floor cleaning tool	41 cm / 16 in	1	  
CL7400-18	131591	18" MicroPad floor cleaning tool	45 cm/ 18 in	1	  



### MicroPad – Wet

Due to a special twisted process the micro-wet pads keep their shape longer and prevent less linting in comparison to other types of pads.

MicroPad Wet pads are made with ultra fine micro fibers which remove more dirt and bacteria than old traditional methods.

New generation Velcro backing lasts longer, holds up better against repeated launderings and attaches more securely to our frame

MicroPad Wet pads are designed to withstand repeated washings and are sewn for superior strength with a polyester fringe.

- No internal sponge allows our MicroPad Wet pads to launder and dry better in commercial driers.
- MicroPad Wet pads last 25-35% longer than economy wetpads.
- "Can be used with our 18" MicroPad floor cleaning tool CL7400-18 / 131591

Old Product Code	NEW Code	Product Description	Size	Pack	Application
MF4018	131600	18" MicroPad wet pad – blue	45.7 cm/ 18 in	6	  



## MicroPad Dry

MicroPad Dry pads are made with 100% ultra fine microfibers. They are able to remove and hold more dirt and bacteria than old traditional methods

Using the micro dry pad gives you 40 times more floor surface coverage than traditional string mops.

- New generation Velcro backing lasts longer, holds up better against repeated launderings and attaches more securely to our frames
- Pile weight 720gr/m<sup>2</sup>
- Can be used with our 18" MicroPad floor cleaning tool CL7400-18 / 131591

Old Product Code	NEW Code	Product Description	Size	Pack	Application
MF5018	131602	18" MicroPad Dry pad	45.7 cm/ 18 in	6	  



## MicroPad Dry With Fringe

With the added looped fringe the micro-dry pad pick up and hold more dust and larger debris. Pads are made with ultra fine 100% ultra fine microfibers. Will remove and hold more dirt and bacteria than old traditional methods.

Using the micro-dry pad gives you 40 times more floor surface coverage than traditional string mops.



- MicroPad Dry with fringe pads are designed to withstand repeated washings and are sewn for superior strength with a polyester fringe.
- Pile weight 720gr/m<sup>2</sup>
- Can be used with our 18" MicroPad floor cleaning tool CL7400-18 / 131591

Old Product Code	NEW Code	Product Description	Size	Pack	Application
MF5518	134743	18" MicroPad Dry pad with fringe	45.7 cm/ 18 in	6	  



## MicroPad Scrubby







The MicroPad Scrubby removes small scuff marks and shoe markings without scratching floors. It's easy to put on the handle and is not attached to any handle allowing the operator to use their foot when stubborn dirt is encountered.

Old Product Code	NEW Code	Product Description	Size	Pack	Application
MF4200	502245	MicroPad Scrubby – blue	51 x 50 x 55 cm/ 20.08 x 19.69 x 21.65 in	1	  



## Wall Washing Systems









- This Wall Washing System is designed to wash and dust hard to reach areas where machine cleaning is impossible such as: corners, edges, stair wells and walls.
- Units features a 360° swivel action and accommodate both tie-on style mop head and velcro style mop head.
- Attaches securely to holder with Velcro or in a tie-on style
- Detachable cotton refill can be removed easily for laundering.

Old Product Code	NEW Code	Product Description	Size	Pack	Application
WI940-01	135032	9" Tie on style cotton mop – cut end	23 cm/ 9 in	12	  
WI940-02	135324	Frame and handle for item WI940-01	137 cm/ 54 in	1	  



## Doodle Bug Frame & Refill

- Attaches securely to holder with Velcro style grip
- Detachable cotton refill can be removed easily for laundering.
- Attach refill securely to holder with Velcro style back
- Our cotton dust mops are absorbent and economical.
- Constructed of a four-ply high quality cotton yarn that is sewn onto a durable polyester backing.
- All our cotton dust mops feature more yarn fill than competitive mops on the market which translates to even greater dust retention.
- The Doodle Bug Frame can also be used with our abrasive utility pads  
Handle not included – FH372EX-NT/ 135365

Old Product Code	NEW Code	Product Description	Size	Pack	Application
WI17-048	135327	Doodle Bug flat sticky frame only	23 cm/ 9 in	1	  
WI17-100	135031	Doodle Bug sticky style cotton mop – cut end	23 cm/ 9 in	12	  
MF4009	134741	MicroPad wet pad for Doodle Bug	22.9 cm/ 9 in	6	  

## Caution Signs

### Wet Floor Signs











Floor signs alert the public to the dangers of slippery, wet floors or other hazards that pose a safety risk. The 28 inch tall signs fold for convenient storage and are printed on both sides in English, French and Spanish.

- Bright yellow floor signs communicate the necessary warning message to help maintain safety.

**Size:** 72 x 32 x 22.5 cm / 28½ x 12¾ x 9 inch



Old Product Code	NEW Code	Product Description	Size	Pack	Application
MI7003	134775	Floor Sign "Caution Wet Floor" – English/ French	72 x 23 x 33 cm/ 28.35 x 9.06 x 12.99 in	6	  
MI7005	134777	Floor Sign "Caution Wet Floor" – English	72 x 23 x 33 cm/ 28.35 x 9.06 x 12.99 in	6	  
MI7007	134779	Floor Sign "Caution Wet Floor" – English/ Spanish	72 x 23 x 33 cm/ 28.35 x 9.06 x 12.99 in	6	  

### Safety Cone



4 Sided Safety Caution Cone is ideal for any environment where warning must be seen from all directions

- Durable one piece construction
- Easy to clean and sanitize
- Space saver – Cones are stackable
- Highly visible bright yellow colour
- English, French and Spanish









Old Product Code	NEW Code	Product Description	Size	Pack	Application
WF1000-1ES	135026	4 Sided Safety Cone	91.4 cm/ 36 in	5	  



## Hanging Door Signs

Door frame sign will block doorways from 89 to 122 cm / 35 to 48 inches.

- Helps prevent access to restricted areas
- Signs are made of heavy duty vinyl material for long life
- Can be rolled up for easy storage
- Door frame handle (135029) must be ordered with sign to complete







Old Product Code	NEW Code	Product Description	Size	Pack	Application
WF9001	135027	Hanging Door sign "Closed for Cleaning" – Eng/ Spanish	for 109 cm/ 43 in opening	6	  
WF9002	135028	Hanging Door sign "Closed for Cleaning" – Eng/ French	for 109 cm/ 43 in opening	6	  
FWHANDLE	135029	Door Frame Handle for 135027 and 135028	for 109 cm/ 43 in opening	6	  



## Wax Applicators

- High quality washable waxing pad, secures firmly in place around hardwood block, with wing nuts which allows for easy pad replacement.
- Wax applicator accommodates any standard threaded handle which are sold separately.



Old Product Code	NEW Code	Product Description	Size	Pack	Application
MI4216B	134770	Wood block only – with wing nuts	41 cm/ 16 in	10	  
MI4216R	134771	Waxing pad refill	41 cm/ 16 in	10	  



# UltraFlex.

The features you want.  
The options  
you deserve.



Double buckets



Ergonomic extended legs



Multiple scaling units



Colour coding system



Locking mechanism

# UltraFlex...

## As good as wet mopping gets!



If you are looking for the most up-to-date, innovative and ergonomic bucket-and-wringer system on the market – look no further.

It's here and it's the UltraFlex system from Vileda Professional – Marino. Engineered from the ground up, UltraFlex has been designed to perform the most hygienic cleaning of floors available today!

### Steps to proper floor cleaning

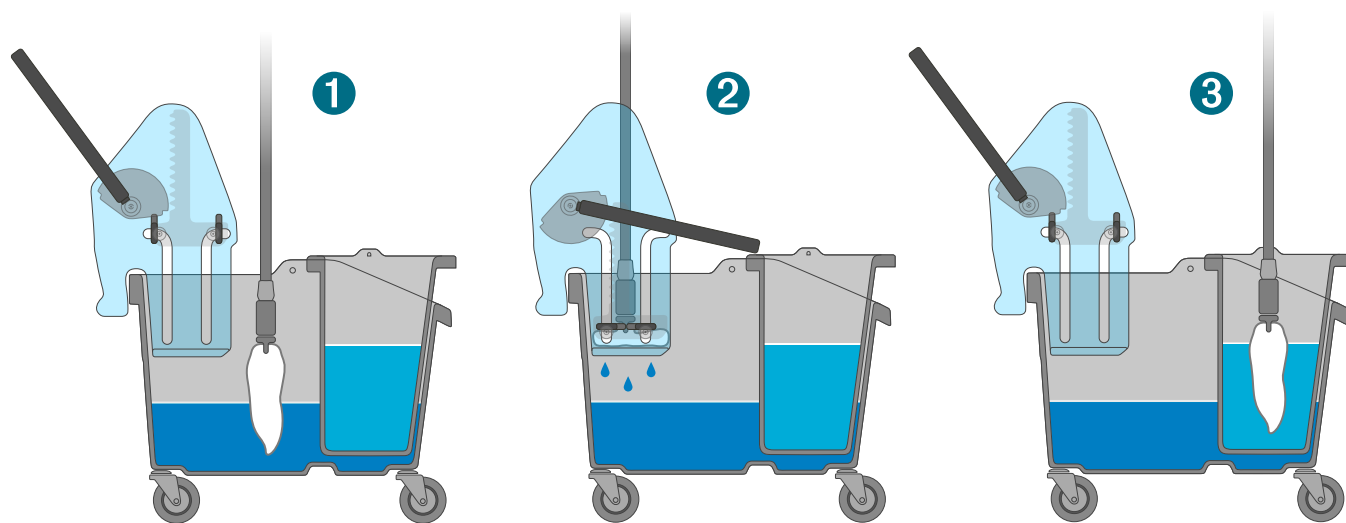

After cleaning a portion of the floor, you now rinse your soiled mop in the dirty water compartment. This is done to remove any access dirt from the mop before it enters the clean water compartment.

It is recommended that you wring the mop at this stage before the mop enters the clean water.

Once the mop has been submerged into the clean water, you will now wring out the mop to the desired moisture level. Continue to clean your floor, repeating steps one and two.

### Top in class ergonomics

Having healthy personnel pays off in the long run, and one way of reducing wear and tear and body stress is providing cleaning tools with top class ergonomics.

UltraFlex has several features that all lead in the direction of offering your cleaning staff tools that are easy-to-handle, easy-to-use and with a minimum of uncomfortable movements.

- Extended leg design prevents excessive bending minimizing back strain
- Downpress wringer reduces the wringing force needed
- Bails and support grips for easy handling
- Adjustable telescopic handle (optional)
- Lightweight and easy-to-handle buckets

### Top class economy

From the beginning of the UltraFlex development, one clear goal was to offer users unbeatable cleaning economy.

The ergonomic properties are, of course, an important parameter, where a healthy cleaning staff clearly contributes to your bottom line.

More obvious and with a faster pay-back is the effective down press, which reduces water release to the floor and thereby gets your floors ready for traffic in no time.

In addition, the clean water bucket configuration reduces water consumption and increases the cleaning area.

And above all – when working with UltraFlex you can feel and sense the overall high quality in every component, the basis for a long and trouble-free service life.

For a detailed video demonstration please visit our website: [vileda.com](http://vileda.com)

## UltraFlex Downpress/Sidepress Complete

UltraFlex Basic features a large 34 litre/36 quart bucket and is the ideal configuration when the need is just an effective, regular mopping system with strength and durability at the forefront of the design.

In this configuration, UltraFlex can be put on the Vileda Professional – Marino Origo trolleys as well as most janitorial carts.



- German Engineered / Stylish Design
- Easy glide stainless steel castors
- Colour coding to reduce cross contamination
- Conforms with foodservice standards



Code	Description	Size	Pack	Application
133879	UltraFlex Bucket with Castors and Downpress Wringer	53 x 37 cm / 21 x 14 1/2 in	1	
137560	UltraFlex Bucket with Castors and Sidepress Wringer	53 x 37 cm / 21 x 14 1/2 in	1	

## UltraFlex Bucket with Castors

UltraFlex Bucket with Castors features a large 34 litre/36 quart bucket and is the ideal configuration when the need is just an effective, regular mopping system with strength and durability at the forefront of the design.

- German Engineered / Stylish Design
- Easy glide stainless steel castors
- Colour coding to reduce cross contamination



Code	Description	Size	Pack	Application
133878	UltraFlex Bucket with Castors - 34 L / 36 Qt.	53 x 37 cm / 21 x 14 1/2 in	1	

## UltraFlex Extended Leg Combos

### Ergonomic Single Bucket System

UltraFlex Ergonomic Single Bucket System offers the added benefit of extended leg design which helps prevent excessive back bending.

The large 34 litre/36 quart bucket is the ideal configuration when the need is just an effective, mopping system with strength, durability and ergonomics at the forefront of the design.

The ergonomic leg option is sure to keep your staff healthy with minimal back strain

- German Engineered / Stylish Design
- Easy glide stainless steel castors
- Colour coding to reduce cross contamination
- Conforms with foodservice standards



Code	Description	Size	Pack	Application
136022	UltraFlex Bucket with Extended Legs and Downpress Wringer	53 x 37 cm / 21 x 14 1/2 in	1	
137561	UltraFlex Bucket with Extended Legs and Sidepress Wringer	53 x 37 cm / 21 x 14 1/2 in	1	



## UltraFlex Bucket-In-Bucket System

- Integrated, second clean water compartment to prevent cross contamination.
- Easily identify clean water from dirty water and to prevent cross contamination.
- The clean water bucket locks into place when in use and is easily removable for emptying and filling.
- UltraFlex can be put on the Vileda Professional - Marino Origo trolleys and most janitorial carts.
- Can also be used for waxing applications
- Conforms with foodservice standards



Code	Description	Size	Pack	Application
136021	Bucket-in-Bucket (Clean Water Bucket) - 15 L / 16 Qt.	36 x 36 cm / 14 x 14 in	1	



## UltraFlex Ergonomic Extended Legs

The addition of the UltraFlex extended leg design offers the added benefit which helps prevent excessive back bending.

- Provides a strong ergonomic benefit for users
- Increased manoeuvrability
- Conforms with foodservice standards
- One pack provides a complete set of 4 legs



Code	Description	Size	Pack	Application
136020	Ergonomic Extended Legs (Set of 4)	17 x 11 cm / 6 1/2 x 4.2 in	4	



## Snap-N-Go With Telescopic Handle

Use this handle to further improve ergonomic benefits for your cleaning staff

- Lightweight but strong aluminum telescopic handle.
- Ergonomic centre grip and anti-slip handle grip.
- Different lengths for different users
- Conforms with foodservice standards



Old Product Code	New Code	Description	Size	Pack	Application
MH7000EXT	131605	Snap-N-Go with telescopic handle and colour rings (BRYG)	100 x 180 cm / 40 x 71 in	1	

## Buckets & Wringers

**Our bucket and wringer combos are designed to meet the demanding requirements of the most sanitary environments.**

- Our buckets are manufactured from high quality plastic that is injection molded.
- Unlike conventional foam buckets, our buckets are absolutely smooth, strong, durable, and easy-to-clean and sanitize which reduces breeding ground for bacteria.

### Downpress Combos

- Gears and pressure plates, fiber reinforced nylon.
- Quiet, smooth operation, easy to work with and ideal for high standards of cleaning.
- More efficient wringing; also avoids water splashing on the floor.
- Single bail carry handle eliminates pinching problem.
- Durable ball bearing casters provide smooth, easy movement.
- Accommodates all wet mop sizes 340 g to 900 g / 12 oz to 32 oz and fits all bucket types and sizes.
- Reduces need to stock different wringers resulting in less inventory.
- Convenient opening for mop access, extended casters for stability.
- Extended casters minimize possibility of tipping.
- The durable stain resistant one piece construction is easy to clean and sanitize and does not provide a breeding ground for bacteria.
- Downward pressure wringer forces water into bucket more effectively.



BL GR YE PLEASE SPECIFY COLOUR WHEN ORDERING.



Old Product Code	NEW Code	Product Description	Size	Pack	Application
MA1232-40B	134704	Downpress bucket & wringer combo – blue	25-38 L/ 26-40 qt	1	
MA1232-40G	134706	Downpress bucket & wringer combo – grey	25-38 L/ 26-40 qt	1	
MA1232-40Y	131580	Downpress bucket & wringer combo – yellow	25-38 L/ 26-40 qt	1	
MA1232-40Y-PRISON	134709	Downpress bucket & wringer combo with prison safety features – yellow	25-38 L/ 26-40 qt	1	
MA2633BL	134719	Downpress bucket & wringer combo – blue	25-30 L/ 26-32 qt	1	
MA2633GR	134721	Downpress bucket & wringer combo – grey	25-30 L/ 26-32 qt	1	
MA2633YE	131582	Downpress bucket & wringer combo – yellow	25-30 L/ 26-32 qt	1	
MA2633YE-PRISON	134724	Downpress bucket & wringer combo with prison safety features – yellow	25-30 L/ 26-32 qt	1	



## Junior and Sidepress Combos

### Junior Sidepress Combo

- Economical alternative to our MA1133
- Small design for quick manoeuvrability in smaller areas
- Handle can be inserted for left and right hand operations
- Slide-out water divider.



### Sidepress Combo

- Our sidepress bucket and wringer combos are designed to meet the demanding requirements of the most sanitary environments
- Our buckets feature single bail handle which eliminate the possibility of pinching and 7.6 cm / 3 inch non-marking ball bearing casters that provide smooth easy movement, guaranteed not to fall out.
- The durable stain resistant one piece construction is easy to clean and sanitize and does not provide a breeding ground for bacteria
- Quiet, smooth operation, easy to work with and ideal for general building cleaning, restaurants and hotels.
- Convenient opening for mop access

Old Product Code	NEW Code	Product Description	Size	Pack	Application
MA1011YE	134700	Junior sidepress bucket & wringer combo – yellow only	21 L/ 22 qt	1	
MA1133YE	134702	Sidepress bucket & wringer combo – yellow only	25-30 L/ 26-32 qt	1	



## Utility Buckets And Pails

- Our high impact plastic utility buckets are available in two styles and feature a sturdy handle for easy carrying.
- The large 13 liter / 14 quart capacity bucket with molded wide spout for easy pouring is useful for a variety of washing jobs in any environment.
- Buckets are stackable for easy storage.

Old Product Code	NEW Code	Product Description	Size	Pack	Application
BU1013	134490	Plastic pail – 11L	11 L/ 12 qt	12	
BU14G	134492	Plastic pail – 13L	13 L/ 14 qt	6	

## Buckets



- All of our buckets feature molded graduations to facilitate accurate measurements.
- Our buckets feature a flared base for greater stability to minimize the possibility of tipping.
- Available in a choice of attractive colours — blue, yellow and grey — ideal to prevent cross-contamination in any sanitary environment.
- Buckets are designed to provide a conveniently large opening for mop access with the wringer attached.

■ BL    ■ GR    ■ YE    PLEASE SPECIFY COLOUR WHEN ORDERING.



Old Product Code	NEW Code	Product Description	Size	Pack	Application
MA2603BL	134715	Bucket with 7.6 cm/ 3 in castors – blue	25-30 L/ 26-32 qt	1	
MA2603GR	134717	Bucket with 7.6 cm/ 3 in castors – grey	25-30 L/ 26-32 qt	1	
MA2603YE	134718	Bucket with 7.6 cm/ 3 in castors – yellow	25-30 L/ 26-32 qt	1	
MA2640BL	134725	Bucket with 7.6 cm/ 3 in castors – blue	25-48 L/ 26-40 qt	1	
MA2640GR	134727	Bucket with 7.6 cm/ 3 in castors – grey	25-48 L/ 26-40 qt	1	
MA2640YE	134729	Bucket with 7.6 cm/ 3 in castors – yellow	25-48 L/ 26-40 qt	1	

## Downpress Wringers





- The Downpress wringer is injection molded with high density polymer and features a strong durable smooth surface that is easy to clean and sanitize.
- Unlike foam plastic wringers, our wringer does not provide a breeding ground for bacteria.
- Gears and pressure plates are fiber reinforced nylon which allows for quiet and smooth operation.
- Eliminate the need to stock various sized wringers. The wringer is designed to effectively wring all wet mops from 340 g to 900 g / 12 oz to 32 oz.
- The downward pressure style is especially designed to “better” wring all mop heads and engineered to force water directly into the bucket.
- Available in a choice of 3 attractive colours to co-ordinate with our buckets.

Old Product Code	NEW Code	Product Description	Size	Pack	Application
MA1232BL	134710	Downpress wringer – blue		1	
MA1232GR	134711	Downpress wringer – grey		1	
MA1232YE	134713	Downpress wringer – yellow		1	
MA1232YE-PR	134714	Downpress wringer with prison security – yellow only	32 x 32 x 75 cm/ 12.6 x 12.6 x 29.53 in	1	











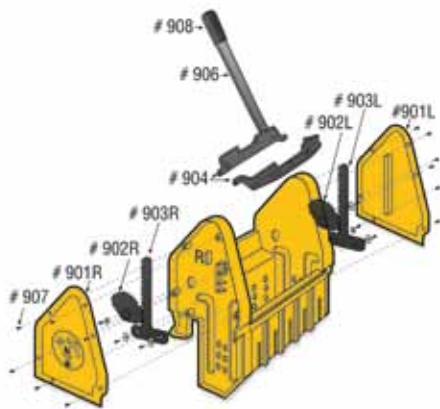

























































## Sidepress Wringers

- The Sidepress wringer is injection molded with high density polymer and features a strong durable smooth surface that is easy to clean and sanitize.
- Unlike foam plastic wringer, our wringer does not provide a breeding ground for bacteria.
- Gears and pressure plates are fiber reinforced nylon which allows for quiet and smooth operation.
- Eliminate the need to stock various sized wringers. The wringer is designed to effectively wring all wet mops from 340 g to 900 g / 12 oz to 32 oz.

Old Product Code	NEW Code	Product Description	Size	Pack	Application
MA1132-YE	519647	Sidepress wringer – yellow only	32 x 30 x 75 cm/ 12.6 x 11.81 x 29.53 in	1	  

## Parts List For Downpress Wringer and Castors





Old Product Code	NEW Code	Product Description	Pack	Application
FM1232-IN	519765	Wringer insert – black	1	  
MA901L-BL	520499	Wringer left side plate – blue	1	  
MA901L-GR	520510	Wringer left side plate – grey	1	  
MA901L-GR-BLANK	520511	Wringer left side plate – grey no logo	1	  
MA901L-YE	520513	Wringer left side plate – yellow	1	  
MA901R-BL	520514	Wringer right side plate – blue	1	  
MA901R-GR	520515	Wringer right side plate – grey	1	  
MA901R-GR-BLANK	520516	Wringer right side plate – grey no logo	1	  
MA901R-YE	520518	Wringer right side plate – yellow	1	  
MA902L	519837	Wringer left half moon gear	1	  
MA902R	519838	Wringer right half moon gear	1	  
MA903L	519839	Wringer left T- gear	1	  
MA903R	519840	Wringer right T- gear	1	  
MA904	519841	Wringer pressure bars – set of 2 ea	2	  
MA906	520205	Wringer handle only	1	  
MA907	519843	Wringer complete hardware set – screws	1	  
MA908	520206	Black plastic grip for wringer/mop handle	1	  
MA911	520208	Inner spring for wringer	1	  
MA912	519849	Handle for 32 qt bucket	1	  
MA913	520210	Handle for 40 qt bucket	1	  
MA920	520211	Compressing spring	1	  
MA909	520207	Mop bucket casters - set of 4	4	  





## Double Bucket with Cone Wringer

- Our high impact plastic utility buckets feature a sturdy handle for easy carrying.
- Snap-on cone wringer is ideal for yacht mops and other small mops.



















Old Product Code	NEW Code	Product Description	Size	Pack	Application
BU10721W	134491	Double bucket with cone wringer and wheels	17 L/ 18 qt	4	  



## Window/Wax Buckets

- Casters fit the window bucket allowing simple movement of heavy buckets
- Single and double hangers fit on pails to hold window cleaning tools



Old Product Code	NEW Code	Product Description	Size	Pack	Application
PUW01130	131587	Window/ wax bucket only – blue	20 x 46 x 23 cm/ 8 x 18 x 9 in	1	  
PUW01131	131585	Window/ wax bucket only – red	56 x 31 x 87 cm/ 22.05 x 12.20 x 34.25 in	1	  
PUW01135	135343	Lid for window/ wax bucket only – blue		1	  
PUW01140	135083	Set of 4 casters	50 x 30 x 30 cm/ 19.69 x 11.81 x 11.81 in	4	  
PUW01143	134974	2 Double hangers for the window/wax bucket		1	  
PUW01144	134975	2 Single hangers for the window/wax bucket		1	  



## Utility Buckets/Pail

- Sturdy handle for easy carrying.
- Buckets are stackable for easy storage.
- These buckets feature a snap-on cone wringer that is ideal for yacht mops and other small mops.
- Refer to yacht mops on pages 20 and 21

Old Product Code	NEW Code	Product Description	Size	Pack	Application
SU122704	122705	Supermop bucket and cone wringer	12 L / 12.8 qt	1	  



## All Purpose Caddy

- Made with durable plastic
- Great for carrying a wide variety of cleaning tools

Old Product Code	NEW Code	Product Description	Size	Pack	Application
HB10	135634	All purpose caddy	42 x 29 x 22 cm/ 16.5 x 11.5 x 8.5 in	1	  

# PUSHBROOMS



## Pushbrooms



## The Right Selection

Stiffness, durability, resilience and cost are a few of the characteristics that will determine the fiber better suited for the task at hand. Choosing the proper broom for the job will provide more efficient sweeping at a lower cost.

Generally speaking, natural fibers are better suited for fine sweeping on smooth surfaces such as tile, hardwood and linoleum. Those brooms with a combination of natural and synthetic fibers are more suitable for medium sweeping on semi-rough surfaces. Brooms constructed from stiffer synthetic fibers are better suited for coarse surfaces and concrete. Heavy debris would also require coarse sweeping brooms.

When choosing a broom, one must also consider the area to be swept. With larger areas, We recommend using a 24"/60cm broom or larger, with a broom brace.

Whatever your needs, we offer the ideal broom for the job.

### Push Brooms

- We offer what we believe to be the finest push brooms on the market.
- All of our pushbrooms are constructed with a premium quality hardwood block or a heavy duty plastic block.
- Every pushbroom is staple set with the finest quality fibers.
- Our pushbrooms are more densely filled than our competitors' push brooms.
- Blocks range in length from 14" to 36" and come equipped with two threaded handle holes.

## Understanding Fibers



### Horsehair

Horsehair is a natural fiber that comes from the tail or mane of a horse. The fiber is considered a soft to moderately stiff material that offers good texture and resilience. Horsehair withstands water and moisture and may be used pure or blended with other materials. The soft texture of the fiber makes it ideal for cleaning smooth floors. It is commonly used for scratchless cleaning of highly polished areas.

**Ideal For: Indoor Applications, Fine Dust Cleaning, Smooth Surface.**



### Polystyrene

Polystyrene is a synthetic fiber that is also known as "silver flagged". The fiber withstands moisture and has excellent wearing properties. When the ends are flagged, the styrene allows for more fine dust retention. Ideal for smooth surfaces and hardwood floors.

**Ideal For: Usage with many strong solvents.  
Can be used in temperatures of up to 180° F / 82° C**



### Tampico

Tampico is a natural fiber that is creamy white in colour, however, the fibers are dyed black. Tampico has a soft to medium texture with excellent durability. The fiber is water resistant with high heat, acid and alkaline resistant properties. Tampico is frequently mixed or blended with other materials to vary texture and properties. It is a good wearing and highly versatile fiber. Ideal for "all purpose" or medium sweeping.

**Ideal For: Wet or Dry Applications. Acid and alkaline resistant.**

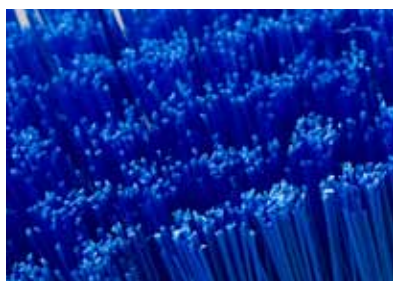

### Nylon

Nylon is a synthetic fiber with excellent wearing qualities. Nylon is water resistant and won't absorb moisture, therefore discourages bacterial growth. Its high heat resistance and resistance to most acids enable the fiber to be long wearing and highly sanitary. Nylon is widely used in food service brushes due to its resilience and durability. It offers the highest quality and superior performance one requires in environments with high sanitary standards.

**Ideal For: Foodservice applications to meet the needs of high sanitary standards.**

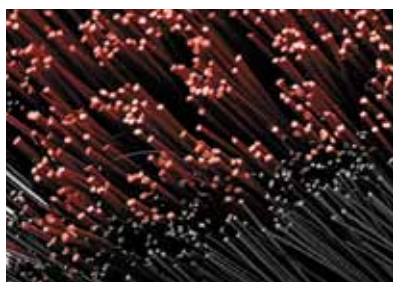

### Polypropylene

Polypropylene is a synthetic fiber available straight or crimped in a variety of colours. The fiber is very light with excellent resilience to acid and most solvents. Polypropylene has poor recovery from crushing, however, it can be used in hot water and has good wearing properties.

**Ideal For: Usage with many strong solvents/acid and abrasive scrubbing.**



### Bassine

Bassine is a natural fiber that is obtained from the select and stiffer portions of the palmyra palm. It is the superior quality or the select grade of palmyra fiber. Bassine is both durable and water resistant, which makes it an ideal choice for stiff scrubbing applications.

**Ideal For: Outdoor usage where stiff scrubbing is required (wet and dry).**



## Trooper Garage Pushbroom





- Trooper's connector brackets and 1 1/8 inch thick tapered handle provide added strength and sturdiness.
- Extra-long heavy duty blue/black plastic fill.
- Ideal for contractors, landscapers, roofers, city maintenance workers and the farming industry.
- **Shipped pre-assembled**

Old Product Code	NEW Code	Product Description	Size	Pack	Application
BR700-BL18	134483	18" Trooper with poly pro fill, brace, & tapered handle	46 cm/ 18 in	4	  
BR700-BL24	134484	24" Trooper with poly pro fill, brace, & tapered handle	60 cm/ 24 in	4	  



## Trooper All-Purpose Pushbroom - Flagged







- The combination of the outer flexible flagged silver bristles and medium stiff red inner plastic fill make this Trooper ideal for general all purpose cleaning
- Trooper's connector brackets and 1 1/8 inch thick tapered handle provide added strength and sturdiness.
- Ideal for general indoor and outdoor cleaning, around schools, warehouses, parking lots, malls or offices.
- **Shipped pre-assembled**

Old Product Code	NEW Code	Product Description	Size	Pack	Application
BR700-SR18	134488	18" Red SilverflagTrooper with styrene fill, brace & tapered handle	42 cm/ 18 in	4	  
BR700-SR24	134489	24" Red SilverflagTrooper with styrene fill, brace & tapered handle	60 cm/ 24 in	4	  



## Trooper Combo Synthetic Pushbroom



- Trooper's connector brackets and 1 1/8 inch thick tapered handle provide added strength and sturdiness.
- A black Polypropylene border surrounds the stiff red Polypropylene centre which effectively combines medium sweeping of heavier debris.
- Ideal on semi-smooth to rough surfaces for medium to coarse sweeping and the fibers are not affected by water, grease, oil and most chemicals.
- **Shipped pre-assembled**

Old Product Code	NEW Code	Product Description	Size	Pack	Application
BR700-RB18	134485	18" Trooper with combo synthetic fill, brace, & tapered handle	46 cm/ 18 in	4	  
BR700-RB24	134486	24" Trooper with combo synthetic fill, brace, & tapered handle	60 cm/ 24 in	4	  



## Trooper Street/Barn Pushbroom

- Heavy-Duty bristles resist stains and odors and is designed for the most demanding conditions
- Ideal for wet or dry pick up.
- Angled brace adds support and stability
- Shipped pre-assembled

Old Product Code	NEW Code	Product Description	Size	Pack	Application
BR700-SBP16	134487	16" Trooper street broom with thick poly pro fill, brace & tapered handle	41 cm/ 16 in	4	  

## Display Packaging



## Tampico Combo

- We have conveniently packaged the pushbroom head with the handle for a shelf display environment.
- Tampico is a flexible and long wearing fiber that is ideal for both industrial and commercial cleaning indoor and out.
- **Assembly required**

Old Product Code	NEW Code	Product Description	Size	Pack	Application
BR220T14CT	134458	14" Tampico complete broom with handle	137 cm/ 54 in	12	  
BR220T18CT	134460	18" Tampico complete broom with handle	137 cm/ 54 in	12	  
BR220T24CT	134462	24" Tampico complete broom with handle	137 cm/ 54 in	6	  



## Garage Combo

- We have conveniently packaged the pushbroom head with the handle for shelf display environment.
- Durable heavy duty polystyrene makes this broom ideal for sweeping the heaviest soils on rough surfaces in wet or dry applications.
- Ideal for usage with a variety of strong solutions
- Withstands temperatures of up to 180° F / 82° C

Old Product Code	NEW Code	Product Description	Size	Pack	Application
BR224G14CT	134470	14" Garage broom complete with 137 cm/54 in handle	35 cm/ 14 in	12	  
BR224G18CT	134472	18" Garage broom complete with 137 cm/54 in handle	138.5 x 30 x 13.5 cm/ 54.53 x 11.81 x 5.31 in	12	  
BR224G24CT	134474	24" Garage broom complete with 137 cm/54 in handle	140 x 30 x 13.5 cm/ 55.11 x 9.92 x 5.12 in	6	  

## Polystyrene Fill - Fine Sweep



### Wood Block

- Ideal for fine sweeping on smooth surfaces, such as tile, linoleum and hardwood floors.
- Ideal for usage with a variety of strong solvents
- Withstands temperatures of up to 180° F / 82° C

Old Product Code	NEW Code	Product Description	Size	Pack	Application
BR219SF18	134455	18" Styrene fill broom head – wood	45 cm/ 18 in	10	  
BR219SF24	134456	24" Styrene fill broom head – wood	60cm/ 24 in	10	  
BR219SF36	134457	36" Styrene fill broom head – wood	90 cm/ 36 in	2	  

## Horsehair Mix - Fine Sweep



### Wood Block

- Excellent for all types of smooth floor cleaning.
- Ideal for fine dust and dirt on concrete, wood or tiled floors.
- Ideal combination of horsehair and synthetic fiber ensures durability and shape retention in both wet and dry applications.







Old Product Code	NEW Code	Product Description	Size	Pack	Application
BR222M18	134467	18" Horsehair & synthetic mix broom head – wood	45 cm/ 18 in	10	  
BR222M24	134468	24" Horsehair & synthetic mix broom head – wood	60cm/ 24 in	10	  
BR222M36	134469	36" Horsehair & synthetic mix broom head – wood	90 cm/ 36 in	2	  

## Tampico Fill - Medium Sweep



### Wood Block

- Best all purpose fiber for fine to medium sweeping, excellent on smoother surfaces such as tile, wood and sealed concrete.
- Tampico is a flexible and long wearing fiber that is ideal for both industrial and commercial cleaning indoor and out.

Old Product Code	NEW Code	Product Description	Size	Pack	Application
BR220T18	134459	18" Tampico fill broom head – wood	45 cm/ 18 in	10	  
BR220T24	134461	24" Tampico fill broom head – wood	60cm/ 24 in	10	  
BR220T36	134463	36" Tampico fill broom head – wood	90 cm/ 36 in	2	  



## Polypropylene Fill - Medium Sweep

### Wood Block

- An all purpose medium sweep for indoor and outdoor cleaning for both industrial and commercial applications.
- Can be used with strong solvents/acid and abrasive scrubbing

Old Product Code	NEW Code	Product Description	Size	Pack	Application
BR221P18	134464	18" Polypropylene fill broom head – wood	45 cm/ 18 in	10	  
BR221P24	134465	24" Polypropylene fill broom head – wood	60cm/ 24 in	10	  
BR221P36	134466	36" Polypropylene fill broom head – wood	90 cm/ 36 in	2	  



## Combination Synthetic Fill - Medium Sweep

### Wood Block

- A black Polypropylene border surrounds the stiff red Polypropylene centre which effectively combines medium sweeping of heavier debris.
- Ideal on semi-smooth to rough surfaces for medium to coarse sweeping and the fibers are not affected by water, grease, oil and most chemicals.





Old Product Code	NEW Code	Product Description	Size	Pack	Application
BR216RB18	134447	18" Black/red synthetic combo synthetic fill broom head – wood	45 cm/ 18 in	10	  
BR216RB24	134448	24" Black/red synthetic combo synthetic fill broom head – wood	60cm/ 24 in	10	  
BR216RB36	134449	36" Black/red synthetic combo synthetic fill broom head – wood	90 cm/ 36 in	2	  



## Bassine Palmyra Fill - Coarse Sweep

### Wood Block

- Coarse natural bassine fiber is long wearing and sweeps the most stubborn soils effectively on both wet and dry surfaces.
- Ideal for sweeping larger debris on coarse surfaces such as concrete, asphalt and brick found in sidewalks, driveways, basements and garages.

Old Product Code	NEW Code	Product Description	Size	Pack	Application
BR217BF18	134450	18" Bassine fill broom head – wood	45 cm/ 18 in	10	  
BR217BF24	134451	24" Bassine fill broom head – wood	60cm/ 24 in	10	  
BR217BF36	134452	36" Bassine fill broom head – wood	90 cm/ 36 in	2	  









## Horsehair and Bassine Fill - Coarse Sweep

### Wood Block

- An exceptional combination of a horsehair for fine dust and a bassine centre ideal for heavier debris.

Old Product Code	NEW Code	Product Description	Size	Pack	Application
BR218HB18	134453	18" Horsehair/ bassine fill broom head – wood	45 cm/ 18 in	10	  
BR218HB24	134454	24" Horsehair/ bassine fill broom head – wood	60cm/ 24 in	10	  



## Garage/Concrete - Coarse Sweep

### Wood Block

- Durable heavy duty polystyrene makes this broom ideal for sweeping the heaviest soils on rough surfaces in wet or dry applications.
- Can be used with strong solvents/acid and abrasive scrubbing

Old Product Code	NEW Code	Product Description	Size	Pack	Application
BR224G18	134471	18" Polystyrene broom head – wood	45 cm/ 18 in	10	  
BR224G24	134473	24" Polystyrene broom head – wood	60cm/ 24 in	10	  
BR224G36	134475	36" Polystyrene broom head – wood	90 cm/ 36 in	2	  



## Stable/Barn Combo - Coarse Sweep







- Excellent for extra rough surfaces, in heavy debris. Can be used in both wet and dry applications.
- Coarse thicker Polypropylene bristles for added stiffness.
- Hardwood block has 2 tapered handle holes.
- Perfect for any heavy commercial sweeping in parking lots, streets and industrial areas. Designed for constant outdoor sweeping and scrubbing.
- Durable heavy duty Polypropylene makes this broom ideal for sweeping the heaviest soils on rough surfaces in wet or dry applications.
- **Assembly required**

Old Product Code	NEW Code	Product Description	Size	Pack	Application
SB225P14CT	134984	14" Stable broom complete with 122 cm / 48 in tapered handle	35 cm/ 14 in	6	  
SB225P14	134983	14" Polypropylene fill street/ barn broom head – wood	35 cm/ 14 in	10	  
SB225P16	134985	16" Polypropylene fill street/ barn broom head – wood	40 cm/ 16 in	10	  



## Broom braces

- All metal braces are constructed to provide excellent reinforcement. They can be connected quickly and easily.
- The short clamp securely fits around any size push broom block for extra handle support. Can be easily tightened using wing nuts.
- Extra handle support reduces handle breakage common with heavy usage.
- Long rod broom brace is ideal for any size push broom from 46 to 61 cm / 24 to 36 inch.
- Brace securely grips threaded handle to provide user with better control and extra support for wide sweeps.
- This extends the life of the handle by reducing breakage at the threads.
- Use one of our sturdy braces and have no fear of broken handles due to overload.

Old Product Code	NEW Code	Product Description	Size	Pack	Application
MI351-BLK	134768	Broom brace – black	32 x 28 x 36 cm/ 12.6 x 11.02 x 14.17 in	12	  
07000	134421	Workhorse bracket only	15 x 14 x 4 cm/ 5.9 x 5.51 x 1.57 in	12	  



## Foodservice Pushbrooms

Our unique pushbrooms are as functional as they are stylish. The highest quality nylon fibers are inset in a plastic block that resists bacteria.

- Ideal where high sanitary standards are required i.e. foodservice industry, hospitals, etc.
- Colour coded to identify specific cleaning areas



Old Product Code	NEW Code	Product Description	Size	Pack	Application
BR4318B	135469	18" Foodservice push broom – blue	46 cm/ 18 in	1	  
BR4318G	135468	18" Foodservice push broom – green	46 cm/ 18 in	1	  
BR4318R	135467	18" Foodservice push broom – red	46 cm/ 18 in	1	  
BR4318Y	135466	18" Foodservice push broom – yellow	46 cm/ 18 in	1	  
BR4324B	135465	24" Foodservice push broom – blue	60 cm/ 24 in	1	  
BR4324G	135464	24" Foodservice push broom – green	60 cm/ 24 in	1	  
BR4324R	135463	24" Foodservice push broom – red	60 cm/ 24 in	1	  



# BROOMS

## Corn Brooms















- We offers a large variety of corn brooms for any application.
- Our corn brooms are wire bound and nailed to hardwood handles and made using only premium quality corn. They are designed for long life and durability.
- These brooms are excellent for either hard or carpeted floors for routine or heavy-duty cleaning, both indoor and out.



## Industrial

- All industrial corn brooms are both bound with polyester stitching and a heavy duty galvanized wire band to provide added durability and longer life.
- These brooms are best suited for wet or tough sweeping, both indoor and out.
- Applications best suited includes snow removal, warehouses, garages, and any other rugged sweeping.









Item	Old Product Code	NEW Code	Product Description	Size	Pack	Application
1	CB107C	134511	Warehouse corn broom – 3 string 1 wire	142 x 46 x 24 cm/ 56 x 18 x 9 in	12	  
2	CB108	134512	Warehouse corn broom – 2 string 2 wire	142 x 42 x 34 cm/ 56 x 17 x 13 in	12	  
3	CB110	134513	Yard broom – 3 wire 1 string	148 x 52 x 28 cm/ 58 x 21 x 11 in	12	  
4	CB500	134516	Corn/Cane warehouse broom – 1 wire 4 string	144 x 47 x 27 cm/ 57 x 47 x 27 in	12	  

## Household Brooms









- All our household corn brooms are bound with polyester stitching to securely hold the premium quality corn.
- These durable brooms are designed for all purpose sweeping both indoor and out.
- Durable construction will withstand the toughest applications

Old Product Code	NEW Code	Product Description	Size	Pack	Application
CB104	134509	Sidewalk corn broom – 5 string		12	  
CB107	134510	All purpose corn broom – 6 string	143 x 48 x 34 cm/ 56 x 19 x 13 in	12	  



## Lobby Brooms and Whisk

- Corn whisks are a convenient way for a quick clean-up of crumbs, ashes or any dry material.
- They are available in two sizes, small and large, to better suit your needs.
- Both sizes feature a built-in handle and hooks for easy storage.
- All corn whisks come reinforced with three rows of polyester stitching.

Old Product Code	NEW Code	Product Description	Size	Pack	Application
CB102	134507	Large corn broom with metal cap – 3 string	142 x 46 x 24 cm/ 55.91 x 18.11 x 9.45 in	12	  
CB103	134508	Toy/lobby broom		12	  

## Magnetic Brooms



### Flat Block Magnetic Brooms



- These brooms are not affected by water and can be rinsed clean and dry quickly.
- Ideal for smaller areas and quick clean up for household, commercial and light industrial applications.
- **Recommended handle – FH348M /135386**

Old Product Code	NEW Code	Product Description	Size	Pack	Application
MB91ECH	134735	Small flat block magnetic broom – head only		24	  
MB96E	134739	Small flat block magnetic broom with metal handle	122 x 24 x 8 in/ 48.03 x 9.44 x 3.14 in	10	  



### Curved Magnetic Brooms



- These brooms are not affected by water and can be rinsed clean and dry quickly.
- Ideal for smaller areas and quick clean up for household, commercial and light industrial applications.
- **Fits most threaded handles**

Old Product Code	NEW Code	Product Description	Size	Pack	Application
MB93LWB	134736	Large curved block line magnetic broom including wood handle	122 x 30 x 8 cm/ 21.65 x 18.5 x 5.12 in	10	  



### Easy Sweep Magnetic Broom Combo

Easy Sweep is made with the highest quality materials and is constructed with extra long flagged bristles. The extra long bristles allows for easier and cleaner sweeping. Longer bristles, longer lasting.

Old Product Code	NEW Code	Product Description	Size	Pack	Application
MB9513	134738	Combo with 25 cm / 10 inch dustpan with 122 cm / 48 inch metal handle	140 x 30 x 17 cm/ 55.12 x 11.81 x 6.69 in	6	  



## Magnetic Brooms



### Corner Sweep

Our Corner Sweep is made with the highest quality materials and constructed with extra long angled bristles. Angled bristles are ideal for sweeping corners, under counters and hard to reach areas.







- Includes handle

Old Product Code	NEW Code	Product Description	Size	Pack	Application
MI201AB	134758	Large magnetic angle broom	120 x 30 x 8 cm/ 47.24 x 11.81 x 3.15 in	6	  



### Industrial Brooms

- These brooms are not affected by water and can be rinsed clean and dry quickly.
- Ideal for smaller areas and quick clean up for household, commercial and light industrial applications.

Old Product Code	NEW Code	Product Description	Size	Pack	Application
MB100LP	134732	Industrial Large curved block magnetic broom – with handle	123 x 30 x 8 cm/ 48.43 x 11.81 x 3.15 in	10	  
MB100LPH	134733	Industrial Large curved block magnetic broom – head only		24	  



## Stiff and Soft Bristle Angled Brooms

- Long wearing/unbeatable strength and durability
- Flagged bristles effectively trap dirt and dust
- Constructed using Polypropylene fiber which is fused into the plastic block preventing bacteria to be trapped in head.
- **Threaded handle sold separately**



Old Product Code	NEW Code	Product Description	Size	Pack	Application
60803	134416	Stiff bristle angle broom – head only, not flagged	41 x 18.5 x 24 cm/ 16.14 x 7.28 x 9.45 in	12	
60804	134417	Soft bristle angle broom – head only, flagged	41 x 18.5 x 24 cm/ 16.14 x 7.28 x 9.45 in	12	



## Angle Brooms

- Angle brooms are long wearing and unbeatable for their strength and durability.
- They are ideal for cleaning corners, under counters, and hard to reach areas in both wet or dry applications indoor or out.
- Styles #98AB and #99AB are constructed of durable flagged synthetic fiber that is angled to allow effective sweeping of even the hardest to reach places.
- Flagged bristles effectively trap dirt and dust.

### Recommended handles for MI98AB-H

48" Handle – FH348M / 135386

### Recommended handles for MI99AB-H

36" Handle – FH336M / 134617

48" Handle – FH348M / 135386

Old Product Code	NEW Code	Product Description	Pack	Application
MI98AB-H	134789	Large angle broom – head only	24	
MI99AB-H	134792	Small angle broom – head only	24	







## Titan™ Industrial broom

### The all-purpose heavy duty angled industrial broom







- The Titan industrial angled broom features a lightweight yet strong handle with an extra long soft ergonomic grip.
- The long black flagged bristles are made of durable Polypropylene and can withstand many harsh chemicals in virtually any environment

Old Product Code	NEW Code	Product Description	Size	Pack	Application
MB3000	134734	Titan Industrial Broom with metal Handle & foam grip	137 cm / 54 inch	6	  



## Rail/Switch Brooms

- We produce two switch brooms constructed of Polypropylene fibers that are unaffected by water, acids, oils and most chemicals and do not harbor bacteria.
- Fibers are enclosed in a metal cap and bound with a galvanized wire band ensuring their strength and durability.
- Ideal for household and industrial use where heavy duty clean-ups and sweeping are required – indoor or out.
- Chisel used for scraping or chipping.

Old Product Code	NEW Code	Product Description	Size	Pack	Application
CB111	134514	Polypropylene switch broom with stiff brown fiber & rounded end	163 x 19 x 30 cm/ 64.17 x 7.48 x 11.81 in	6	  
CB112	134515	Polypropylene switch broom with stiff brown fiber & chiseled end	163 x 30 x 30 cm/ 64.17 x 11.81 x 11.81 in	6	  

## Handles



### Threaded Lacquered Wood Handles

- Threaded lacquered wood handles available in 122, 137 and 152 cm / 48, 54 and 60 inch with standard threads to fit numerous products.
- We offer many threaded and tapered style handles to best suit your every need or task at hand.

Old Product Code	NEW Code	Product Description	Size	Pack	Application
FH348	134618	Threaded lacquered wood handle – 15/16" Diameter	121.9 cm/ 48 in	25	
FH360/UPC	134629	Threaded lacquered wood handle – 15/16" Diameter	152.4 x 2.4 cm/ 60 x 15/16 in	25	
FH360-118	134630	Threaded lacquered wood handle – 1/8" Diameter	152.4 cm/ 60 in	25	
FH354UPC	134625	Threaded lacquered wood handle – 15/16" Diameter	137.2 x 2.4 cm/ 54 x 15/16 in	25	



### Tapered Wood Handles

- Tapered handles are constructed from hardwood and are available in 2.39 or 2.86 cm

Old Product Code	NEW Code	Product Description	Size	Pack	Application
FH354WT	134626	Thin tapered handle – wood – 15/16" Diameter	137.2 cm/ 54 in	25	
FH348T	134620	Thick tapered wood handle – 1 1/8" Diameter	121.9 x 2.9 cm/ 48 x 1-1/8 in	25	
FH354TUPC	134624	Thick tapered wood handle – 1 1/8" Diameter	137.2 x 2.9 cm/ 54 x 1-1/8 in	25	
FH360T-UPC	134641	Thick tapered wood handle – 1 1/8" Diameter	152.4 x 2.9 cm/ 60 x 1-1/8 in	25	



### Metal Tip Wood Handles

- Threaded metal tip wood handles available in 122, 137 and 152 cm / 48, 54 and 60 inch with standard threads to fit numerous products.
- Choose from a selection of metal tip threaded and tapered style handles to best suit your every need or task at hand.

Old Product Code	NEW Code	Product Description	Size	Pack	Application
FH354MFUPC	134622	Threaded wood, metal tip handle	137.2 x 2.4 cm/ 54 x 15/16 in	25	
FH360MF-1	134638	Threaded wood metal tip handle	152.4 cm/ 60 in	25	
FH360MFUPC	134639	Threaded wood metal tip handle	152.4 x 2.4 cm/ 60 x 15/16 in	25	
FH396MF-T	135363	Threaded metal tip & tapered wood handle	243.8 cm/ 96 in	1	



## Colour Coded Fiberglass Handles

- **Lightweight, yet strong** – Composite properties maximized by advanced Pull-Winding process, ensuring maximum strength and ergonomics.
- **Colourful** – Standard colours are yellow, red, blue, and green
- A durable hygienic fiberglass handle with a nylon standard threaded tip guaranteed not to absorb moisture and bacteria.
- Colour coded fiberglass handles that match our pushbrooms to easily identify specific cleaning areas
- Ideal where high sanitary standards are required i.e. foodservice industry, hospitals, etc.



- Available in 152 cm / 60 inch.
- Conforms with foodservice standards



Old Product Code	NEW Code	Product Description	Size	Pack	Application
FH360FB	134633	Fiberglass threaded handle – 15/16" Diameter – grey with blue grip	152.4 cm/ 60 in	10	
FH360FG	134634	Fiberglass threaded handle – 15/16" Diameter – grey with green grip	152.4 cm/ 60 in	10	
FH360FR	134635	Fiberglass threaded handle – 15/16" Diameter – grey with red grip	152.4 cm/ 60 in	10	
FH360FY	134637	Fiberglass threaded handle – 15/16" Diameter – grey with yellow grip	152.4 cm/ 60 in	10	



## Non Threaded Fiberglass Handles

- A durable hygienic fiberglass handle withstands moisture and bacteria.
- Ideal where high sanitary standards are required i.e. foodservice industry, hospitals, etc.

Old Product Code	NEW Code	Product Description	Size	Pack	Application
FH360NTFB	134640	Non-threaded Fiberglass handle – grey	152.4 x 2.4 cm/ 60 x 15/16 in	10	



## Threaded Handle

- Lightweight metal handle with threaded metal tip and handle cap
- Fits most magnetic and angled brooms

Old Product Code	NEW Code	Product Description	Size	Pack	Application
FH348M	135386	Metal handle with threaded tip & hanger cap – white	121.9 cm/ 48 in	24	
FH360M	136418	Metal threaded handle – black	149.9 x 2.4 cm/ 60 x 15/16 in	24	



## Anodized Threaded Handle

- A durable hygienic aluminum handle with nylon standard threaded tip guaranteed not to absorb moisture and bacteria.

Old Product Code	NEW Code	Product Description	Size	Pack	Application
FH360A	134631	Aluminum threaded handle	152.4 cm/ 60 in	10	



## Extension Handles

- Ideal when used with any cleaning tool to reach high or out of the way areas.

Old Product Code	NEW Code	Product Description	Size	Pack	Application
FH372EX-NT	135365	Non-threaded aluminum extension handle	182.9 in/ 72 in	1	
FH378EX	135364	Threaded metal extension handle – blue & white	198 cm/ 78 in	1	



## Telescopic Threaded Handle

Use this handle to further improve ergonomic benefits for your cleaning staff

- Lightweight but strong aluminum telescopic handle.
- Ergonomic centre grip and anti-slip handle grip.
- Different lengths for different uses
- Extends from 100 – 180 cm / 40 – 70 inches



Old Product Code	NEW Code	Product Description	Size	Pack	Application
FH360EXT	135148	Vileda threaded telescopic handle and colour rings (BRYG)	100 – 180 cm/ 40 – 71 in	1	



## Tapered Adaptor

- Quickly converts a variety of threaded handles into a tapered end

Old Product Code	NEW Code	Product Description	Size	Pack	Application
MI35	519883	Tapered adaptor – black		10	



## Lobby Dust Pans – Plastic and Metal

**Our MI800 series of Lobby Dust Pans feature a large tray and a long aluminum handle.**

The larger tray is able to hold more and features a better refined edge which is ideal for brushing in finer particles. Our lobby dust pan has been specially designed with a better angled slope which prevents dirt particles and liquid spillage from escaping once swept in. The longer lightweight aluminum handle allows for a more ergonomic usage and eliminates bending. We offer a choice of lobby brooms, from an angled to a poly toy broom. The choice is yours.

- Ideal for spot cleaning in any commercial, industrial and janitorial application, indoor or out.
- No bending necessary.
- The metal lobby dust pan is available in a rich black finish with a 30 cm / 12 inch self closing lid to prevent debris from spilling.



Item	Old Product Code	NEW Code	Product Description	Size	Pack	Application
1	MI800	134781	Plastic lobby dust pan	89 x 31 x 29 cm/ 35.04 x 12.20 x 11.42 in	6	
2	MI800-H	134782	Handle for the plastic lobby dust pan		6	
3	MI802	134784	Combo: Plastic pan, angle broom, Snap-on Handle	89 x 31 x 29 cm/ 35.04 x 12.20 x 11.42 in	6	
4	MI806	134785	Lobby dust pan with ERGO Handle	46 x 36 x 37 cm/ 18.11 x 14.17 x 37 in	6	
5	MI810	134787	Metal lobby dust pan – Black	41 cm/ 16 in	6	



## Metal Threaded Handles

- Lightweight metal handle with threaded metal tip and handle cap
- Fits most magnetic and angled brooms

Old Product Code	NEW Code	Product Description	Size	Pack	Application
FH336M	134617	Metal lobby broom handle – white	91.4 x 2.2 cm/ 36 x 7/8 in	12	
FH360M	136418	Metal threaded handle – black	149.9 x 2.4 cm/ 60 x 15/16 in	1	



## Dust Pans

- Hand-held dust pans are available in plastic or metal.
- Our dust pans come equipped with hang up handle and are fine line edged which allows for maximum pick up.
- Our heavy duty plastic dust pans are molded from high impact Polypropylene that won't crack, chip, dent and withstands rough treatment
- Ideal for spot cleaning in any household, commercial, industrial and janitorial application, indoor or out.











Old Product Code	NEW Code	Product Description	Size	Pack	Application
MA614	134730	Heavy duty plastic dust pan – black only	30cm/ 12 in	12	  
MA715	134731	Metal dust pan	30cm/ 12 in	12	  
MI206D	134763	Dust pan and banister Brush set	41 x 365 x 33 cm/ 16.14 x 143.7 x 12.99 in	12	  



## Dustpan Sweeper

- The ergonomic and efficient alternative to conventional dustpan sets
- Allows direct removal of dirt, dust and liquid directly into the bag
- Adjustable to accommodate different bag sizes
- Trolley hook for easy attachment to workstations
- High efficiency durable rubber blade
- Best option for quick and easy removal and disposal of waste.
- Ideal for hospitals and nursing homes
- Bag not included



Old Product Code	NEW Code	Product Description	Size	Pack	Application
SW119914	512363	Open lobby dustpan – metal	35 cm / 14 in	1	  
SW119908	119909	Dustpan squeegee sweeper	35 cm / 14 in	1	  
SW119938	512389	Squeegee refill	35 cm/ 14 in	1	  



## Tool Bracket Holder

- Free up your work space with our Tool Bracket. The tools you use most often such as, mop handles, brooms, brushes, pushbrooms, etc. are held firmly, yet released quickly.
- Sliding clips make it easy to adjust spacing.
- Tool Bracket can accommodate 7/8" to 1 1/8" standard diameter handles.
- Additional clip holders can be added.



Old Product Code	NEW Code	Product Description	Size	Pack	Application
TL100	135597	Single clip holder only	37 x 34 x 30 cm/ 14.57 x 13.39 x 13.39 in	1	
TL103	131621	3 clip tool bracket bar	46 cm/ 18 in	12	
TL105	131622	5 clip tool bracket bar	91 cm/ 36 in	4	



## Display Stand

- The stand helps keep product neat and organized.
- Proper storage of product will protect against careless damaging, decrease replacement cost and extend the life of your products.
- By attractively displaying product, customers will be able to view product offered at a glance, therefore increasing sales.
- Ideal for displaying new products.



- Can be used for a variety of long handled products such as pushbrooms, mops, mop handles etc.

Old Product Code	NEW Code	Product Description	Size	Pack	Application
10000CC	134389	Broom Display Stand	50 X 50 X 76 cm/ 23.23 X 19.69 X 29.92 in	1	
PDQ-BRG18P/54M	134928	Garage 18 in/45 cm floor broom with metal handle and PDQ box		28	
PDQ-CB108	134929	Corn broom 2 string 2 wire with PDQ box		32	
PDQ-MP5000CT	136144	Cut End Mop Combo with Snap & Go Handle and PDQ box		48	

# BRUSHES









## Whitewash/Masonry

- Professional wallpaper brush, 9 inch wide with wood block and handle give a high quality professional finish with all wallpaper hanging
- Also used for masonry for applying cement, water paints and liquid waterproofing materials on concrete block and masonry walls

Old Product Code	NEW Code	Product Description	Size	Pack	Application
AB207L	134428	Large whitewash brush with wood block & Tampico fill	57 x 35 x 18 cm/ 22.44 x 13.78 x 7.09 in	30	  



## Counter Brushes - Wood Block

- Our choice of counter brushes are available with a variety of fills
- Horsehair fiber is the softest fill and is considered the best for fine dusting and cleaning of surfaces.
- Tampico fiber is a natural long wearing fiber that is considered ideal as an all purpose brush for any surface. Commonly used to dust, clean equipment and pick up metal chips and dirt.
- Polypropylene fiber is a medium stiff fiber that is great for all purpose dusting and is ideal for picking up larger debris.
- Features a hanger hole for easy storage

Item	Old Product Code	NEW Code	Product Description	Size	Pack	Application
1	AB206T	134427	Counter Brush with wood block & Tampico fill	20 cm / 7.9 in	12	  
2	AB206P	134426	Wood block with trim – Polypropylene fill	19 cm / 7.5 in	12	  
3	AB206M	134425	Wood block with trim – Horsehair mix fill	18 cm / 7 in	12	  



## Carpet Brushes

- Available in an 20 cm / 8 inch hardwood block.
- Carpet brushes can either be hand held or can be used with a standard threaded handle.
- Polypropylene is a stiff fiber for both all purpose scrubbing and heavy duty scrubbing.

Old Product Code	NEW Code	Product Description	Size	Pack	Application
AB228P	134434	Carpet Brush with wood block & poly pro fill		20	  



## Vehicle Brushes

Green high density premium fiber for washing large glass panes, finished metals and tile.

- All blocks come with standard threaded flow through design for attaching a flow through handle.
- Vehicle brushes are flagged to allow for scratchless cleaning of even the most expensive painted surfaces.
- **All vehicle brushes require a threaded handle.**

Old Product Code	NEW Code	Product Description	Size	Pack	Application
AB300F	134438	Vehicle brush with green flagged fill	25 cm/ 10 in	10	  



## Vehicle Brushes with Bumpers

- Heavy-duty block is 9" long, 2-1/2" wide and approximately 1-1/2" thick
- Densely-filled with green Nylex, trim 2-3/8".
- Vinyl bumper protects vehicle finishes.
- Available in a choice of green high density filament or acid resistant fiber that is resistant to common cleaners, detergents or acids.
- Versatile product is ideal for cleaning vehicles, windows, siding and walls.
- **Designed for use with flow-through, threaded or tapered handle.**
- **Handle sold separately**

Old Product Code	NEW Code	Product Description	Size	Pack	Application
AB302B	134439	Vehicle brush with bumper & green flagged fill	23 cm/ 9 in	10	  



## Acid Resistant Brushes

- 2-1/2" wide x 10" long flow-through plastic block with threaded and tapered handle holes. Vinyl bumper protects vehicle finishes. Black and white self-flagged polystyrene bristles. Trim 2-1/2"
- Our window brushes are staple set into foamed polyethylene blocks with standard threaded hole that feature flow through design for attaching a flow through handle.
- **All window brushes require a threaded or flowthrough handle**
- **Handles not included**

Old Product Code	NEW Code	Product Description	Size	Pack	Application
AB300AR	134437	Acid resistant brush – grey & white	25 cm/ 10 in	10	  



## Window Brushes

- Brushes are staple set into polyethylene blocks with a standard threaded hole that features a flow through design for attaching a flow through handle.
- Brushes are densely filled to ensure maximum water retention and are great for cleaning glass, siding, screens, outdoor fixtures and other outdoor items.
- **All window brushes require a threaded or flowthrough handle**
- **Handles not included**

Old Product Code	NEW Code	Product Description	Size	Pack	Application
AB205VT	134424	Window brush with white Tampico fill	20 cm/ 8 in	10	  









## Window/Baseboard Brushes

### Round Brushes

- The White Tampico bristles are staple set into a plastic block that has two standard threaded holes.

### Corner Brushes

- Corner brushes are designed to help scrub hard to reach places such as corners and base boards.
- Stiff Polypropylene bristles
- **All window brushes require a threaded or flowthrough handle**
- **Handles not included**

Old Product Code	NEW Code	Product Description	Size	Pack	Application
AB205BB	134422	Corner baseboard brush		12	  
AB205RVT	134423	Round Tampico window brush – white	60 X 45 X 14 cm/ 23.62 x 17.72 x 5.51 in	12	  











## Utility Deck Scrub Brushes

- Our utility deck scrub brushes are made with an 11" sanded hardwood block with tapered handle hole.
- Ideal for light to heavy scrubbing of floor surfaces, wood or grouted tiles, for both smooth and rough surfaces.
- Scrub brushes feature a heavy duty neoprene squeegee blade that is securely attached and allows for quick water removal.

### Available in choice of three fills:

- **Bassine** – Ideal for hard scrubbing on rough surfaces, removes heavy dirt easily.
- **Polypropylene** – Ideal for scrubbing any dirt on smooth surfaces.
- **White Tampico** – Ideal for all types of scrubbing on smooth and rough surfaces.

Item	Old Product Code	NEW Code	Product Description	Size	Pack	Application
1	AB226B	134431	Brush with bassine fill & squeegee	28 cm/ 11 in	20	  
2	AB226S	134432	Brush with Polypropylene fill & squeegee	28 cm/ 11 in	20	  
3	AB226VT	134433	Brush with white Tampico fill – 3.18 cm/ 1.25 in trim	28 cm/ 11 in	20	  



## Hand Scrubs

- The hand scrub brushes are produced with a pointed block for efficient cleaning in tight areas and corners.
- The white tampico fiber is a natural fiber that is ideal for light scrubbing and won't scratch.
- Plastic fibers are great when coarse scrubbing is required.

Old Product Code	NEW Code	Product Description	Size	Pack	Application
AB229HWT	134435	Hand scrub with wood block & white Tampico fill	23 cm/ 9 in	20	
AB229RP	134436	Hand scrub with Plastic block & Plastic fiber fill	15 cm/ 6 in	24	



## Hand and Nail Brushes

- White Polypropylene stock with polyester white filling.
- A requirement in all food factories and food handling facilities .

Old Product Code	NEW Code	Product Description	Size	Pack	Application
MI405P	134769	Double side plastic nail brush	9 cm/ 3.5 in	12	



## Foodservice Brushes

- Foodservice brushes are made of a durable Polypropylene block available in two lengths, 23 or 51 cm / 9 or 20 inch.
- Ideal for tough scrubbing in kitchens, hospitals, hotels or any food service industry where high sanitary standards are set.
- The short handled brushes are ideal for many uses, from mixing bowls, soup kettles
- Long handle assists in scrubbing deep pots and vats while short handle eliminates knuckle scrapes.
- Polypropylene fill is for medium to heavy scrubbing.
- Versatile scrubs can be used in virtually any environment.
- Withstand bacteria
- Hang-up hole

Old Product Code	NEW Code	Product Description	Size	Pack	Application
AB210SW	134430	Short handle pot brush – white fiber	22.9 cm/ 9 in	6	
AB210LV	134429	Long handle pot brush – white fiber	50.8 cm/ 20 in	6	



## Assorted Grout and Detail Brushes

- Universal scrub quickly swivels in any direction to clean floors, walls, baseboards and confined areas
- The rugged plastic block will not absorb water and stands up to chemicals
- Grout brush allows you to clean narrow grout lines
- **Handles not included ( Items 1 and 2 )**
- **Standard threaded handle recommended**



Item	Old Product Code	NEW Code	Product Description	Size	Pack	Application
1	60702W	135586	Large universal scrub – white	36 x 27x18 cm/ 14.25 x 10.5 x 7 in	1	  
2	60709	135584	Grout Brush with white bristles	43 x 26 x 10 cm/ 17 x 10.25 x 4 in	1	  
3	60712	134415	Detail Brush – white	9.25x 7.5x 2.75 in	12	  
4	60306	134405	Grout cleaner with nylon bristles	19 x 10 x 5 cm/ 7.5 x 3.75 x 2 in	12	  
5	60307	134406	Grout cleaner with stainless steel bristles	19 x 17 x 8 cm/ 7.5 x 6.75 x 3.25 in	12	  



## Bi-Level





- Dual-surface scrub brush uses side bristles that make scrubbing baseboards and corners easy, without having to change tools. Crimped yellow polypropylene bristles provide liquid-holding ability under machines and fixed equipment or in wide open areas. 10" foam plastic block with threaded handle hole.
- **Standard threaded handle recommended**
- **Handles not included**

Old Product Code	NEW Code	Product Description	Size	Pack	Application
60707	135585	Bi-level brush – yellow	28 x 13 x 10 cm/ 11 x 5 x 4 in	1	  



## Wire Scratch Brushes





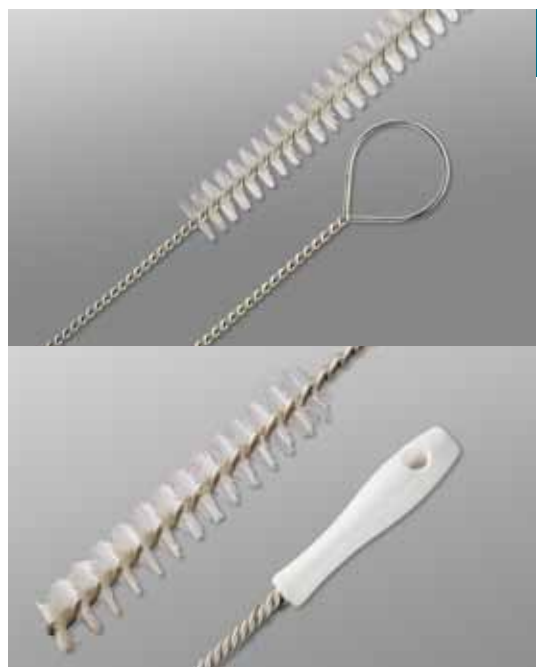

- We offers a variety of heavy duty wire scratch brushes.
- These durable brushes are designed to remove rust, scale, chips of paint and varnish from all surfaces.
- These brushes are constructed of black tempered or stainless steel wire bristles with a traditional hardwood block and come with hang up holes.
- Essential tools for a variety of industries such as welding and plating operations, plumbing, painting and machine shops.

Old Product Code	NEW Code	Product Description	Size	Pack	Application
BR1037	134445	Brush with curved handle & steel wire	36 x 38 x 64 cm/ 14.17 x 14.96 x 25.2 in	12	  
BR1037S	134446	Brush with curved handle & steel wire with scraper	36 x 38 x 64 cm/ 14.17 x 14.96 x 25.2 in	12	  



## Twisted Pro Scrubs

- Twisted pro scrubs are specially designed to reach within, around or along the surface of various equipment.
- Brushes are designed to clean all glass and Pyrex® pots and dispensers
- For cleaning fryers and cooling systems
- Designed to withstand high temperatures.

Old Product Code	NEW Code	Product Description	Size	Pack	Application
60501	134409	Starbright shape scrub with stainless steel wire & nylon bristles	33 cm/13 in	12	  
60504	134410	Fryer Brush, straight shape with stainless steel wire, Teflon bristles & plastic Handle	68x10x 7.6 cm/ 27x 4x3 in	5	  



## Boot And Shoe Cleaner

- The shoe and boot cleaner is ideal in high traffic areas that are prone to dirt and debris such as construction sites, schoolyards and industrial areas.
- Helps eliminate bacteria, dirt, and other contaminants from being tracked into food processing areas













Old Product Code	NEW Code	Product Description	Size	Pack	Application
60707-BT	134413	Boot and shoe cleaner	42.5 x 33 x13 cm/ 16.73 x 12.99 x 5.12 in	1	  

## Floor Squeegees



### Straight Metal Frame Squeegees

- Heavy metal frames are zinc plated, therefore corrosion resistant and features a **built in scraper** designed for removal of stubborn stains.
- Durable grey/white non-marking blades are secured in place with sturdy rust resistant screws.
- These heavy duty floor squeegees are designed for universal use. Ideal for all industries, professional and commercial.
- All floor squeegees use tapered handles, FH354TUPC / 134624 or FH360TUPC / 134641, depending on choice of lengths
- Replacement blades sold separately.

Old Product Code	NEW Code	Product Description	Size	Pack	Application
FS55618	134651	Grey/white squeegee with steel frame – handle not included	45.7 cm/ 18 in	2	  
FS55624	134652	Grey/white squeegee with steel frame – handle not included	61 cm/ 24 in	2	  
FS55630	134653	Grey/white squeegee with steel frame – handle not included	76.2 cm/ 30 in	2	  
FS55636	134654	Grey/white squeegee with steel frame – handle not included	91.4 cm/ 36 in	2	  



## Curved Metal Frame Squeegees

- These heavy duty floor squeegees are designed for universal use. Ideal for all industries, professional and commercial.
- All floor squeegees use tapered handles, FH354TUPC / 134624 or FH360TUPC / 134641, depending on choice of lengths
- Replacement blades sold separately.

Old Product Code	NEW Code	Product Description	Size	Pack	Application
FS55724	134659	Grey/white complete head – curve	61 cm/ 24 in	2	
FS55736	134660	Grey/white complete head – curve	91.4 cm/ 36 in	2	

Old Product Code	NEW Code	Product Description	Size	Pack	Application
FS556R18	134655	Grey/white squeegee replacement blade	45.7 cm/ 18 in	10	
FS556R24	134656	Grey/white squeegee replacement blade	61 cm/ 24 in	10	
FS556R30	134657	Grey/white squeegee replacement blade	76.2 cm/ 30 in	10	
FS556R36	134658	Grey/white squeegee replacement blade	91.4 cm/ 36 in	10	



## MUS Squeegee

- The “MUS” squeegees are designed to dig deep into tile crevices and uneven surfaces to remove liquids, leaving floors dry.
- Standard double MUS rubber squeegee with rugged galvanized steel construction.
- All floor squeegees use tapered handles, FH354TUPC / 134624 or FH360TUPC / 134641, depending on choice of lengths

Old Product Code	NEW Code	Product Description	Size	Pack	Application
FS18SB	134648	MUS Black standard squeegee – handle not included	45.7 cm/ 18 in	10	
FS22SB	134649	MUS Black standard squeegee – handle not included	55.9 cm/ 22 in	10	
FS30HB	134650	MUS Black heavy duty squeegee – handle not included	76.2 cm/ 30 in	10	



## Plastic MUS Squeegee - Heavy Duty

- Our heavy duty Plastic MUS Squeegee is ideal for removing water and solid or damp dirt from any type of flooring
- Features a heavy-duty plastic frame, flexible blade made of durable soft black closed-cell foam rubber and a universal handle socket for quick assembly.
- All floor squeegees use tapered handles, FH354TUPC / 134624 or FH360TUPC / 134641, depending on choice of lengths







Old Product Code	NEW Code	Product Description	Size	Pack	Application
PUW20045	135534	Heavy duty plastic MUS squeegee	46 cm / 18 in	1	
PUW20055	135533	Heavy duty plastic MUS squeegee	56 cm / 22 in	1	
PUW20075	135532	Heavy duty plastic MUS squeegee	76 cm / 30 in	1	





## Plastic MUS Squeegee with Scrub





- The “MUS” squeegees with a built-in scrub are ideal for patios, decks, garages, basements, driveways and restaurants.
- Durable foam blade construction adapts well on all types of surfaces, even tile and brick.
- Removes water build up quickly
- **All floor squeegees use tapered handles, FH354TUPC / 134624 or FH360TUPC / 134641, depending on choice of lengths**

Old Product Code	NEW Code	Product Description	Size	Pack	Application
60400	134407	Double MUS floor squeegee and scrub in one – handle not included	46 cm/ 18 in	10	  
60401	134408	Double MUS floor squeegee and scrub in one – handle not included	56 cm/ 22 in	10	  



## Plastic Pro

- The only choice for food service applications.
- White “push/pull” blade can be easily reversed for longer life and replaced without the use of tools, simply snap into place.
- The all plastic construction consists of a fiberglass handle, permanently attached to the rugged connector which accommodates all sizes — 46, 61 and 76 cm / 18, 24 and 30 inch.
- The blade is able to withstand extremely hot liquids, grease, petroleum products and most harsh chemicals.
- These squeegees can be easily cleaned therefore ensuring high sanitary standards.

Old Product Code	NEW Code	Product Description	Size	Pack	Application
FS9440	134662	PVC connector, fiberglass handle	137.2 cm/ 54 in	10	  
FS9424R	134661	Plastic Pro blade refill only	61 cm/ 24 in	10	  



## Fiberglass Non-Threaded Handle

- A durable hygienic fiberglass handle withstands moisture and bacteria.
- Ideal where high sanitary standards are required i.e. foodservice industry, hospitals, etc.

Old Product Code	NEW Code	Product Description	Size	Pack	Application
FH360NTFB	134640	Fiberglass, non-threaded handle – grey	152.4 x 2.4 cm/ 60 x 15/16 in	10	  

# Create your own trolley!

As easy as 1, 2, 3



The **Origo** Line. Right now. Right tomorrow.



**1** Step one  
Select your base model



**2** Step two  
Design and customize



**3** Step three  
Save and send

## One great idea.

The main idea behind the Origo Line is to create a trolley that covers every possible cleaning requirement. For now and forever. The outcome is a complete range of trolleys with full flexibility and future-proof adaptability.

## The possibilities are endless.

When you've decided which Origo trolley suits your requirements best, the fun really begins! There are more than 100,000 ways of configuring your Origo trolley to meet your specific requirements.

On the [www.creator.vileda.com](http://www.creator.vileda.com) website you will find the Origo Creator – a configuring tool that is both easy and fun to use. Mix and match, drag and drop, extend and equip – the Origo Creator is where your ideas and visions become reality. And when you've decided on your individual configuration and had the trolley of your dreams delivered to your door, it's just as easy to retrofit it when your requirements change.

**Build your own today!**  
**[www.creator.vileda.com](http://www.creator.vileda.com)**



reddot design award  
winner 2008

## Origo Trolleys



### Origo 300FX

The Origo 300FX is an entry level trolley designed for general use in all cleaning environments. It comes complete with a waste collection and storage area for all your cleaning utensils – Suitable for the Swep, UltraSpeed and UltraFlex Systems.

#### Includes

- Plastic Bin bag holder with support bars
- Two (2) full trays and two (2) six liter buckets
- 4 – 125mm/4 1/4 in turning casters
- Frame holder set (for Origo 300)
- Extension support for laundry/garbage bag – SW122554 / 122555
- Please refer to page 94 for the Origo Duo Wringer Press System
- Bin bag sold separately SW123525/514792
- Assembly required
- Additional accessories available on Pg. 94 – 96



Old Product Code	NEW Code	Product Description	Size	Pack	Application
120769	120769	Origo Trolley 300FX	120 x 40 x 60 cm / 47.2 x 15.7 x 23.6 in	1	
120769-C	134392	Origo Trolley 300FX with locking compartment – see page 96	120 x 40 x 60 cm / 47.2 x 15.7 x 23.6 in	1	



### Origo 300HX

- Suitable for the Swep, UltraSpeed and UltraFlex Systems.
- Option to retro-fit and re-customise if your requirements change in the future.
- Trays slide for easy access.

#### Includes

- Plastic Bin bag holder with support bars
- One (1) full tray
- Frame holder set (for Origo 300)
- extension support and castor for Bin bag holder
- 5 – 125mm/4 1/4 in turning casters
- Two (2) Buckets 6 L/6.3 qt with one set (2 colours/blue, red) coding clips
- Bin bag sold separately SW123525/514792
- Assembly required
- Additional accessories available on Pg. 94 – 96



Old Product Code	NEW Code	Product Description	Size	Pack	Application
120766	120766	Origo Trolley 300HX - Medium	84 x 58 x 100 cm / 33 x 23 x 39 1/2 in	1	
120766-C	134391	Origo Trolley 300HX with locking compartment, plus 1 extra full tray – see page 96	84 x 58 x 100 cm / 33 x 23 x 39 1/2 in	1	



### Origo 300HHX

- Suitable for the Swep, UltraSpeed and UltraFlex Systems.
- Option to retro-fit and re-customise if your requirements change in the future
- Trays slide for easy access.

#### Includes

- Plastic Bin bag holder with support bars
- Three (3) full trays
- Frame holder set (for Origo 300)
- Extension support for Bin bag holder
- 2 Handle holder set
- 4 – 125mm/4 1/4 in turning casters
- Three (3) Buckets 6 L/6.3 qt with one set (3 colours – blue, red, yellow ) coding clips
- Three (3) Swep Pre MopBox with lid and one set blue colour coding clips
- Bin bag sold separately SW123525/514792
- Assembly required
- Additional accessories available on Pg. 94 – 96



Old Product Code	NEW Code	Product Description	Size	Pack	Application
120763	120763	Origo Trolley 300HHX-large	126 x 58 x 100 cm / 50 x 23 x 39 1/2 in	1	
120763-C	134390	Origo Trolley 300 HHX with locking compartment – see page 96	126 x 58 x 100 cm / 50 x 23 x 39 1/2 in	1	

# VoleoFlex.

The compact, versatile and more-with-less trolley

**More than a stand-alone mopping system.  
Less than a full-size trolley. Definitely versatile.**

The VoleoFlex trolley has been developed to bridge the gap between just a mopping system and our Origo full size trolley. It has ample storage space, bin bag holder and allows for usage of both single and double bucket system, including press, or even our Sweb system. But still in a very compact and versatile packaging!



With a dimension of only 112 x 85 x 55 cm / 44 x 33.5 x 21.5 in, VoleoFlex is the ideal solution when space is tight or when the cleaning area is limited. But still, there is enough room for everything you need to perform a professional cleaning mission – both on floor and above floor. Plus a 50 litre zip-locked waste bag with lid for the cleaning plan holder.

## The VoleoFlex range

One big advantage with the VoleoFlex trolley, is that it grows with your needs. As the components and add-ons are fully compatible, the flexibility is high and you can specify the trolley to your exact needs. Without being stuck in a corner when you need to change or upgrade the trolley's setup.

## VoleoFlex Trolleys



### VoleoFlex Basic trolley

Strong, stable solid metal structure

**Includes**

- Two (2) 185mm / 7.25in fixed casters
- Two (2) 100mm / 4in swivel castors
- Two (2) handle holder (120812)
- Two (2) 6L buckets with red and blue clips (120943)
- Plastic half lid for bin bag with red clip (120809)
- Cleaning plan display for bin bag lid (120818)
- Bin bag sold separately SW123525/521793
- Assembly required • Additional accessories available on Pg. 94 – 95



Old Product Code	NEW Code	Product Description	Size	Pack	Application
138126	138126	VoleoFlex Basic Trolley	90 x 55 x 114 cm / 35.4 x 21.7 x 44.9 in	1	



### VoleoFlex UltraSpeed Starter Kit trolley

Strong, stable solid metal structure

**Includes**

- Two (2) 185mm / 7.25in fixed casters
- Two (2) 100mm / 4in swivel castors
- Two (2) handle holder (120812)
- Two (2) 6L buckets with red and blue clips (120943)
- Plastic half lid for bin bag with red clip (120809)
- Cleaning plan display for bin bag lid (120818)
- Bin/Waste laundry bag, 50L (521793)
- Half tray (120813)
- UltraSpeed Starter Kit (114985)
- Telescopic handle sold separately 119967
- Assembly required
- Additional accessories available on Pg. 94 – 95



Old Product Code	NEW Code	Product Description	Size	Pack	Application
138140	138140	VoleoFlex UltraSpeed Starter Kit Trolley	90 x 55 x 114 cm / 35.4 x 21.7 x 44.9 in	1	



### VoleoFlex Pre-prepared trolley

Strong, stable solid metal structure

**Includes**

- Two (2) 185mm / 7.25in fixed casters
- Two (2) 100mm / 4in swivel castors
- Two (2) handle holder (120812)
- Two (2) 6L buckets with red and blue clips (120943)
- Plastic half lid for bin bag with red clip (120809)
- Cleaning plan display for bin bag lid (120818)
- Bin/Waste laundry bag, 50L (521793)
- Half tray (120813)
- Three (3) Swep Pre MopBox (120806)
- Three (3) Swep Pre MopBox Lids (120822)
- Metal tray support for top Swep Pre MopBox (138800)
- Assembly required • Additional accessories available on Pg. 94 – 95



Old Product Code	NEW Code	Product Description	Size	Pack	Application
138129	138129	VoleoFlex Pre-prepared trolley	90 x 55 x 114 cm / 35.4 x 21.7 x 44.9 in	1	

## VoleoFlex Accessories

Old Product Code	NEW Code	Product Description	Size	Pack	Application
138800	138800	Metal tray support for top Swep Pre MopBox		1	
521793	521793	Voleo bin/waste laundry bag with zipper, 50L	50L / 52.5 qt	1	



## Origo Duo Press

The Swep Duo Press enables you to take full and effective use of our flexible Swep Duo mopping system. It is ideal for both pre-prepared mop and bucket and press applications.

- Designed for office environments, residential properties and schools and suitable for hospitals, hotels and restaurants.
- 25 L rectangular bucket to use with flat press – not included (See below for details - SW120944 / 120945)
- Use when pre-impregnation/pre prepared method is not possible
- To be used with the bucket method
- 100% Polypropylene (chassis) and stainless steel (lever)
- Effective pressing of Duo Mops
- Ergonomic lever for maximum pressure with minimum effort
- Robust structure and great durability
- For use with the 300FX Trolley only
- Assembly required



Old Product Code	NEW Code	Product Description	Size	Pack	Application
SW120788	120788	Origo duo press		1	  
SW121841	121841	Origo duo press holder – metal frame to attach trolley		1	  

## Accessories



## Buckets

High quality polypropylene buckets

- 6 L bucket to place on the top of the Origo Trolley incl. 8 colour coding clips
- Can be fitted with the 6 L bucket lid – SW120942 / 125948
- 25 L bucket to use with wringer or press, only with blue clips (part of the UltraSpeed System)
- 25 L rectangular bucket to use with flat press included
- All buckets come with one set eight (8) colour clips (BRYG)



Item	Old Product Code	NEW Code	Product Description	Size	Pack	Application
1	SW120942	120943	Swep bucket with colour clips – (BRYG)	6 L / 6.34 qt	1	  
2	125948	125948	Swep bucket 6 L lid	39.6 x 29.5 x .89 cm/ 15.59 x 11.61 x .35 in	12	  
3	SW120944	120945	Origo rectangular long pail with colour clips (BRYG)	25 L/ 26 qt	1	  



## Mop/Cloth Preparation Box

Manual dosing sieve and preparation MopBox ensures correct dosing of mop pads.









### Prep MopBox

- To prepare mops or cloths for pre-paired cleaning
- Fits on the Origo trolley system – slides in/out to ensure easy pick-up of mops
- Can be stacked on top of each other and used with optional dolly
- Conforms with foodservice standards
- Colour coded clip included - 4 sets (RBYG)

### Sieve

- Fits on top of prep mop box for dosing mops on or off trolley
- Pierced with holes to ensure even dosing of mops









Item	Old Product Code	NEW Code	Product Description	Size	Pack	Application
1	SW120774	120806	Sweep Pre MopBox with set of 8 colour clips (BRYG)		1	  
2	SW120779	120821	Sweep Sieve for Pre MopBox		1	  
3	SW120780	120822	Sweep Lid for Pre MopBox		1	  



## Origo Trays

- Robust trays used to store cleaning utensils
- Half tray stores one 15 L / 18.8 qt or two 6 L / 6.3 qt buckets
- Full tray stores two 15 L / 15.8 qt or 25 L / 26.5 qt or four 6 L / 6.3 qt buckets



Old Product Code	NEW Code	Product Description	Size	Pack	Application
SW120783	120813	Half tray	39 x 28 x 6 cm 15.5 x 11 x 2.5 in	1	  
SW120784	120814	Full Tray	56 x 39 x 6 cm/ 22 x 15.5 x 2.5 in	1	  











## Waste/Laundry Collection

- Strong and durable waste/laundry collection lids available in 2 sizes - 70 L / 18 gal or 120 L / 31.7 gal
- Underside of lid has area for daily instructions



- Instruction sheet helps control daily operations
- Half lid provides the option to separate and into five different areas – half bags



Old Product Code	NEW Code	Product Description	Size	Pack	Application
SW120781	120809	Bin bag half lid including one set of 8 colour clips (BRYG)	70 L / 73 qt	1	  
SW120782	120810	Bin bag full lid including one set of 8 colour clips (BRYG)	120 L / 126.8 qt	1	  
SW120787	120818	Cleaning plan display for under lid		1	  



## Origo Locking Cabinet Components

- Prevents theft by allowing the janitor to lock the cabinet
- Highly recommended where stealing is a potential problem
- Manufactured with extreme strength
- Please specify what model trolley when ordering locking cabinet components – All three (3) components are required
- Assembly required

Old Product Code	NEW Code	Product Description	Size	Pack	Application
SW127477	127477	Origo 300 covering door		1	
SW127479	127479	Origo 300 covering side short		1	
SW127481	127481	Origo 300 covering rear wall		1	

## Origo Parts



Item	Old Product Code	NEW Code	Product Description	Size	Pack	Application
1	127032	513233	Origo caster 125mm	42.8 X 27.8 x 14.10 cm/ 16.9 x 10.9 x 5.6 in	1	
1	127033	514010	Origo caster 125mm, with locking brake	42.8 X 27.8 x 14.10 cm/ 16.9 x 10.9 x 5.6 in	1	
2	SW122578	122579	Support castor kit	12.5 cm/ 4.9 in	1	
3	SW120771	120811	S – Hook		1	
4	SW120772	120812	Handle holder		1	
5	SW120778	120820	Clamping wire for bin bag holder – metal		1	
6	SW120786	120816	Frame holder set – for Origo 300		1	
7	SW122554	122555	Extension support for laundry/waste Bag – for Origo 300		1	
8	SW122572	122573	Rails and cover kit	58 x 40 x 30 cm/ 22.83 x 15.75 x 30 in	2	
9	SW122574	122575	Origo spacer		1	
10	SW123525	514792	Bin/Waste Laundry bag with zipper	120 L / 126.8 qt	1	
11	127033-B	134393	Origo locking mechanism (prevents back wheels from swiveling)	42.8 X 27.8 x 14.10 cm/ 16.9 x 10.9 x 5.6 in	1	



## Jan-Cart 2



### Janitorial Maids Cart

**Features:**

- Smooth easy to clean surface.
- Molded with high density plastic for extra durability.
- Ideal for holding dustpans, floor signs, mop handles, etc.
- Convenient utility hooks, molded directly on the Jan-Cart 2.
- Accommodates most buckets and wringers.
- Non-marking wheels allow for easy movement especially in tight areas.
- Zipped bag

**Size:** 113 x 51 x 98 cm /  
44.4 x 20 x 38½ inch



Old Product Code	NEW Code	Product Description	Size	Pack	Application
CA1700BZ	134493	JAN-Cart 2 – zipped bag only	49 X 43 X 31 cm/ 19.3 x 16.9 x 12.2 in	1	🏠 + 🧹 + 🧼
CA1700Z	134494	JAN-Cart 2 – Janitorial maids cart with bag	88 x 25 x 21 cm/ 34.6 x 9.8 x 8.3 in	1	🏠 + 🧹 + 🧼
CA1701	134495	JAN-Cart 2 – locking cabinet only	36 x 31 x 30 cm / 14.3 x 12.5 x 12 in	1	🏠 + 🧹 + 🧼
CA1702	134496	JAN-Cart 2 - front wheels		1	🏠 + 🧹 + 🧼
CA1703	134497	JAN-Cart 2 - back wheels		1	🏠 + 🧹 + 🧼



## X-Cart

**Features:**

- Smooth easy to clean surface.
- Molded with high density plastic for extra durability.
- Easily collapses for convenient storage.
- Non-marking wheels allow for easy movement especially in tight areas.

**Size:** 65 x 56 x 92 cm / 25½ x 22 x 36½ inch.



Old Product Code	NEW Code	Product Description	Size	Pack	Application
CA1800	134500	X-Cart mobile trolley	113 x 35 x 35 cm/ 44.5 x 13.8 x 13.8 in	1	🏠 + 🧹
CA1800B	134501	X-Cart – bag only	46 x 37 x 37 cm/ 18.11 x 14.6 x 14.6 in	1	🏠 + 🧹
CA1802	134502	X-Cart wheel		1	🏠 + 🧹



## Utility Cart

**Features:**

- 3 large shelves that are smooth and easy to clean.
- Molded with high density plastic for extra durability.
- Handles on both ends for easy maneuverability.
- Non-marking wheels allow for easy movement especially in tight areas.

**Size:** 103 x 51 x 96 cm / 40½ x 20 x 37½ inch.

Old Product Code	NEW Code	Product Description	Size	Pack	Application
CA1850	134503	Utility Cart	103 x 51 x 35 cm/ 40.55 x 20.07 x 13.78	1	🏠 + 🧹
CA1852	134504	Utility Cart wheel		1	🏠 + 🧹











## Hotel/Hospitality Cart

### Features:

- 2 large moveable shelves that are smooth and easy to clean.
- Molded with high density plastic for extra durability.
- Handles on both ends with bag accommodation.
- Non-marking wheels allow for easy movement especially in tight areas.

**Size:** 148 x 55 x 130 cm / 58½ x 21¾ x 51½ inch.

Old Product Code	NEW Code	Product Description	Size	Pack	Application
CA1750	134498	Heavy duty hotel cart		1	  
CA1752	134499	Heavy duty hotel cart wheel		1	  
CA1700BZ	134493	Zipped bag only - optional (fits both Jan-Cart 2 and Hotel Cart)	49 X 43 X 31 cm/ 19.3 x 16.9 x 12.2 in	1	  









## Industrial Cart

### Gladiator

The industrial cart is ideal for use in warehouses, the garage – any place a rugged cart is needed. This rugged service cart features easy-to-clean structural plastic for industrial, medical and food service use. Features a 76.2 cm / 3" deep, leak-proof top tray, plus a 101 cm / 3" deep bottom shelf. Excellent mobility with 4 casters (2 swivel and 2 fixed) and a comfortable push handle. Easy assembly. Rounded edges and corners will not cut or scrape walls or furniture. Lightweight design allows this cart to be easily maneuvered on 127 cm / 5" non-marking casters.

- **Casters:** 13 x 3 cm / 5 x 1¼ inch. non-marking.
- **Colour:** Gray is standard colour.
- **Carrying capacity:** up to 250 lbs

**Size:** 91 x 61 x 81 cm / 36 x 24 x 32 inch, with 10 cm / 4 inch deep tray.

Old Product Code	NEW Code	Product Description	Size	Pack	Application
CA1900	134505	Industrial cart	100 x 32 x 65.5 cm/ 39.38 x 12.6 x 25.79 in	1	  
CA1900W	134506	Industrial cart wheels	13 cm/ 5 in	4	  

# WIPIING



# Above The Floor Cleaning

## **WIPING** 100 – 105

Choosing the right cloth  
Nanotech  
Microstar Contractor  
MicroWindow Big  
Breazy  
MicroValue  
MicroRoll

## **SPONGES & SCOURERS** 106 – 107

Sponges  
Sponges with Scouring Pads  
Scouring Pads

## **DUSTERS** 108 – 110

Microfibre Dusters  
Lambswool Dusters  
Rainbow Magnetic Dusters  
Ostrich Feather Duster  
Swep Duo Duster

## **WINDOW CLEANING** 111 – 117

Window Squeegees  
    Brass Squeegees  
    Stainless Steel Squeegees  
    Replacement Rubbers for Brass &  
        Stainless Steel Squeegees  
    Plastic Squeegees  
    Handy Car/ Window Squeegee  
    Holster  
Scrapers  
Telescopic Poles

# Want to save money, time and stress on wiping? Want to eliminate up to 99.9% bacteria?

The demands on cleaning and wiping performance are rising higher and higher. Keeping the costs down, not only requires wiping larger areas in shorter time, but effectively reducing bacteria growth and the prevention of cross-contamination all in a one step process.

How to do it? Switch to our **“true 100% microfiber”** cloths from Vileda Professional – Marino and leave cotton and similar rags behind. Microfiber is the modern, cost-effective and high-performance way of wiping.

## It performs better

Nothing short of chemicals cleans more effective than Microfiber!

The secret lies in the Microfiber composition, where the ultra-thin (1/100th of a hair!) and endless Microfibers use capillary force to dissolve dirt and absorb liquids in millions of micro-spaces.

This means you wipe away even fatty dirt without the need for chemicals. Also it means that you can eliminate up to 99.9% of bacteria on hygiene sensitive touch areas.

## It's faster

Our ultra fine 100% Microfiber cloths leave behind micro droplets that dry in seconds, which means your surface stays clean longer, and one swift and single wipe will do the job. Without linting, without a second drying.

One-step and streak-free wiping means larger areas can be cleaned in the same amount of time.

Our non-woven Microfiber cloths **dry even faster than traditional woven and knitted Microfiber cloths** which prevent bacterias from growing in the cloth.

## It's more cost effective

Time is money and as you clean faster you cover a larger area in the same amount of time, which means you can easily cut the costs per area cleaned by 50%.

The high product quality means that our durable true 100% Microfiber cloths can be washed more than 500 times\* without losing neither shape nor performance. The result? Lower life cycle costs and improved overall economy.

## It's ergonomic

Vileda Professional – Marino's Microfiber cloths have superior gliding properties that reduce muscular stress, resulting in healthier staff, lower sick leave and thereby lower overall costs.



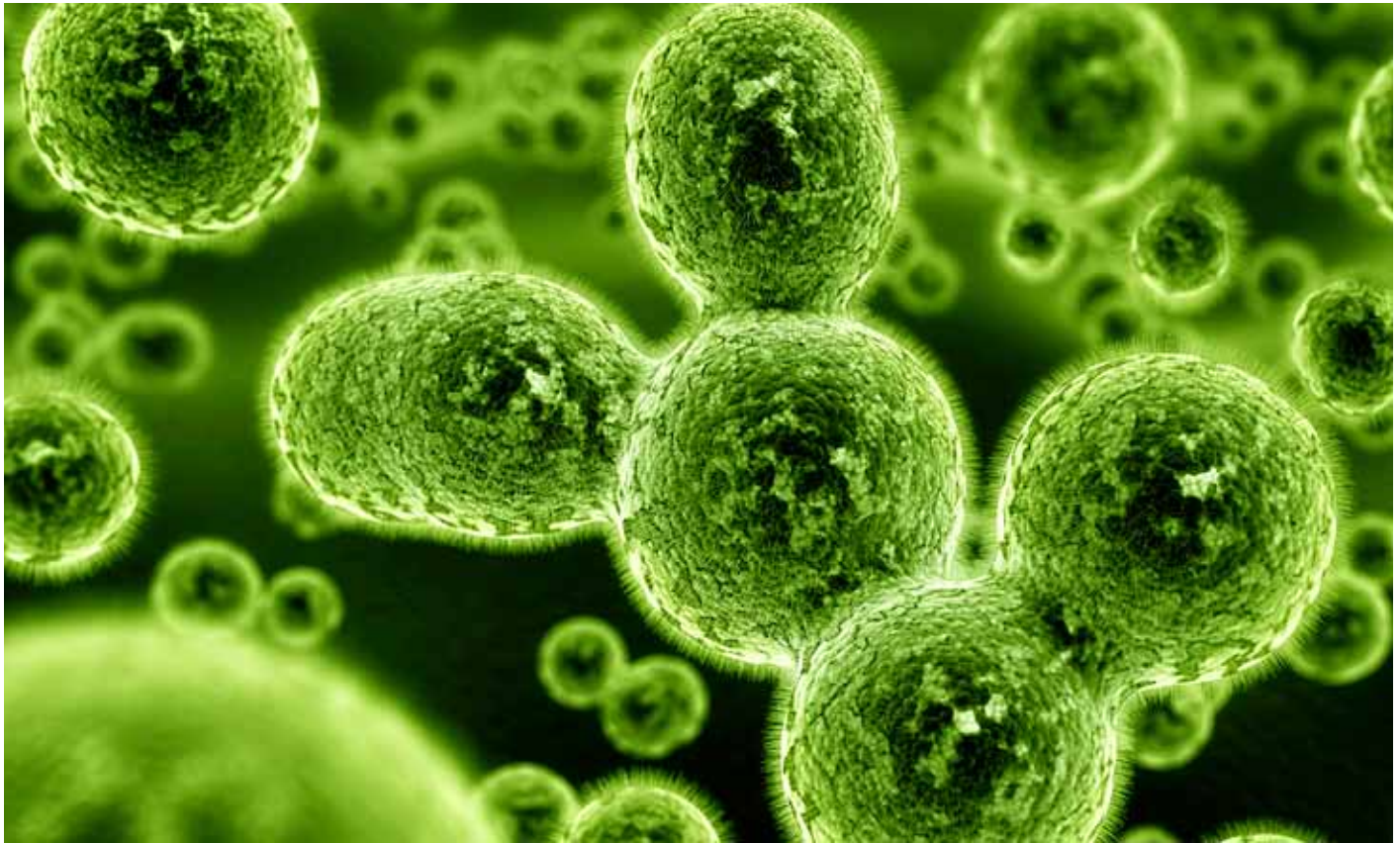

## NanoTech micro - kills bacteria

NanoTech micro is the solution for all operations and environments where maximum touch area hygiene and bacteria reduction is paramount. Highly recommended for all healthcare cleaning.

Not only does it wipe away bacteria, it even kills them in direct contact as nano particles of silver have been embedded in the Microfiber structure. Plus, it has all the appreciated Microfiber properties – high durability, one-step wiping, easy gliding and superior cleaning results.

### Features

- Nanoparticles embedded in the true 100% Microfiber
- Streak free performance
- Pre-prepared and spray bottle method
- Colour coding options (BRYG)
- Tested up to 500 washing cycles
- Minimize chemical use

### Benefits

- Antibacterial  
Eliminates up to 99.9% of bacteria
- One step cleaning – no drying cycle
- Variety of cleaning methods
- Reduced cross-contamination
- Long life span
- Reduced cost / eliminate odor



Old Product Code	NEW Code	Product Description	Size	Pack	Application
128600	128604	NanoTech cloth – yellow	38x 40 cm/ 15x16 in	5	
128601	128605	NanoTech cloth – blue	38x 40 cm/ 15x16 in	5	
128602	128606	NanoTech cloth – green	38x 40 cm/ 15x16 in	5	
128603	128607	NanoTech cloth – red	38x 40 cm/ 15x16 in	5	

Please refer to page 137 for Private Label Program



## MicroStar contractor

MicroStar contract is the economic solution that provides all the required cleaning performance.

### Features

- True 100% Microfiber
- Streak free performance
- Pre-prepared and spray bottle method
- Colour coding options (BRYG)
- Tested up to 500 washing cycles
- Minimize chemical use

### Benefits

- Ability to remove bacteria off of surface
- One step cleaning
- Variety of cleaning methods
- Reduced cross-contamination
- Long life span
- Reduced cost



Please refer to page 135 for Private Label Program



Old Product Code	NEW Code	Product Description	Size	Pack	Application
129406	129420	MicroStar Contractor cloth – blue	40 x40 cm/ 16 x 16 in	25	
129407	129421	MicroStar Contractor cloth – red	40x40 cm/ 16x16 in	25	
129408	129422	MicroStar Contractor cloth – yellow	40x40 cm/ 16x16 in	25	
129409	129423	MicroStar Contractor cloth – green	40x40 cm/ 16x16 in	25	



## Microvalue

MicroValue provides quality cleaning at an affordable price.

### Features

- Pre-prepared and spray bottle method
- Colour coding options (BRYG)
- Tested up to 500 washing cycles
- Minimize chemical use

### Benefits

- Variety of cleaning methods
- Reduced cross-contamination
- Long life span
- Reduced cost



Old Product Code	NEW Code	Product Description	Size	Pack	Application
133622	133642	MicroValue cloth – blue	23 x 23.5 cm/ 9.1 x 9.3 in	25	
133628	133645	MicroValue cloth – green	24 x 23.5 cm/ 9.1 x 9.3 in	25	
133640	133646	MicroValue cloth – red	25 x 23.5 cm/ 9.1 x 9.3 in	25	
133641	133647	MicroValue cloth – yellow	26 x 23.5 cm/ 9.1 x 9.3 in	25	



## Breazy - The New Wave in Wiping

A semi-disposable cloth with microfiber cleaning performance, Breazy can be used on all surfaces including desktops, cupboards, chairs, counters, bars and all washroom surfaces. Breazy is a cloth for all situations and environments. If hygiene and disposability are your key criteria, its price allows you to use it for a day or so, then throw it away, but Breazy is also machine washable up to 15 times. That's why it's called a semi-disposable.

Outstanding dirt pick-up with unique wave-structure and Microfiber properties

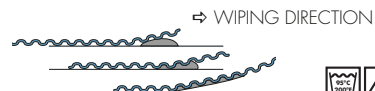

Old Product Code	NEW Code	Product Description	Size	Pack	Application
120119	120124	Breazy cloth – blue	35.5 x 35cm / 14 x13.75 in	25	
120120	120129	Breazy cloth – red	35.5 x 35cm / 14 x13.75 in	25	
120121	120130	Breazy cloth – yellow	35.5 x 35cm / 14 x13.75 in	25	
120122	120131	Breazy cloth – green	35.5 x 35cm / 14 x13.75 in	25	





## MicroWindow Big

MicroWindow big is an extra large cloth with high absorbency because of its size and construction. It performs without leaving streaks and without linting through the patented endless microfibre technology. MicroWindow big is soft and supple for easy handling, but durable when it comes to washing.

### Benefits

- **Productivity through long product lifetime**  
Window cloth is strong and durable both in use and in washing. This pays off through low costs-in-use.
- **Professional appearance of the cleaning site**  
A streakfree cleaning result on all delicate glass surfaces is the best business card you can give.
- **Productivity through large size**  
It is nothing but a fact that a big cloth can absorb more and has a higher m<sup>2</sup> performance.
- 36 x 60 cm / 15 x 14 inches
- **Washable for up to 500 times**



Old Product Code	NEW Code	Product Description	Size	Pack	Application
127373	127375	MicroWindow Big	36x60 cm/ 15x24 in	5	  



## MicroRoll and Dispenser

Lightweight true **100% Microfiber** wipe offering outstanding lint free cleaning performance with a greater than 99.93% removal of bacteria.

With MicroRoll there is no requirement for investment in laundering facilities and staff do not need to change their current cleaning practices. The result is improved cleaning results with no additional workload.

Independent tests carried out by Microsearch Laboratories in the UK have found the following levels of bacteria reduction after just one wipe:

- Machine washable up to 10 times
- **Ideal for outbreaks and isolation wards**



### Clostridium Difficile:

Vegetative form – 99.93%\* • Spore form – 99.94%\*

- MRSA – 99.96%\*

\*BMA Institute – Biologisches Mess-und Analyselabor.



Old Product Code	NEW Code	Product Description	Size	Pack	Application
122583	122583	MicroRoll white	35x25 cm/13.7x 9.7 in	4	  
129459	129459	MicroRoll dispenser	35 x35 cm/13.4 x13.4 in	4	  





## Cellulose Sponge

- Our cellulose sponges are very porous and can hold up to 20 times their weight in water
- Ideal for kitchen and bathroom counters, sinks, faucets, or any application where water can be easily absorbed and released

Old Product Code	NEW Code	Product Description	Size	Pack	Application
MIE745	134793	Cellulose sponge only	15 x 11 x 4.4 cm 6 x 4.5 x 1.75 in	50	  



## MiracleClean

**Tired of pen-marked table tops, scuff-marked floors, limy washbasins, dirty whiteboards, greasy sinks and ground-in dirt in general?**

Try the new, effective MiracleClean. With a minimum of effort, it will instantly take away marks that used to be a problem. No need for aggressive chemicals, no need to struggle and sweat over annoying marks anymore, just dampen MiracleClean in water and rub the mark away.

The ideal problem-solver for spotcleaning. Removes tough marks, stains and ground-in dirt with a minimum of effort where other methods normally fail.

- Works with water only, no chemicals needed
- Works on most surfaces



Old Product Code	NEW Code	Product Description	Size	Pack	Application
CL42100	102751	MiracleClean white sponge	10 x 6.09 x 2.8 cm/ 4 x 2.4 x 1.01 in	12	  





## Non-Abrasive Scourer

Easy Grip non-abrasive super scourer

- All the advantages of the easy grip shape but with a white non-abrasive scouring surface
- Suitable for use on delicate surfaces



Old Product Code	NEW Code	Product Description	Size	Pack	Application
CL1603	102562	Non-abrasive sponge with white scrubber	35 X 33 X 31 cm/ 13.78 x 12.99 x 20.08	10	  



## Synthetic Sponge with Scouring Pad

- Synthetic material is more economical than cellulose but still has good water absorption properties.
- Ideal for kitchen and bathroom counters, sinks, faucets, or any application where water can be absorbed and released.
- Scouring pad adds increased cleaning performance for stubborn stains
- Sponge is securely bonded to scouring pad.

Old Product Code	NEW Code	Product Description	Size	Pack	Application
MISSS	134797	Synthetic sponge with scouring pad	10 x 15 cm/ 4x 6 in	50	  



## Cellulose Sponge with Scouring Pad

- Cellulose sponge material is very porous and can hold up to 20 times their weight in water.
- Ideal for kitchen and bathroom counters, sinks, faucets, or any application where water can be easily absorbed and released.
- Scouring pad adds increasing cleaning performance for stubborn stains.
- Sponge is securely bonded to scouring pad.

Old Product Code	NEW Code	Product Description	Size	Pack	Application
MIE747	134794	Cellulose sponge with scouring pad	9 x 15 cm/ 3.5x 6 in	50	  



## Green Scouring Pads

- For situations where heavy duty cleaning on stubborn dirt is required.
- Ideal for greasy and caked-on pots and pans and all-round cleaning.







Old Product Code	NEW Code	Product Description	Size	Pack	Application
MIHSP1	134795	Green scouring pads	15 x 24 cm/ 6 x 9.5 in	100	  



## Utility Pads

Heavy and light coarse scrubbing pads designed for an assortment of cleaning requirements.







- Can be used with the Doodle Bug Frame and handle to scrub hard to reach areas

Old Product Code	NEW Code	Product Description	Size	Pack	Application
MIUTPBLA	134800	Black utility pads – coarse	25 x 11.7 cm/ 10 x 4.625 in	20	  
MIUTPVH	134801	White utility pads – light	25 x 11.7 cm/ 10 x 4.625 in	20	  

## Microfiber Duo-duster Frame and Handmop



- Highest quality most effective dusting tool in the market
- The slim, flexible frame reaches into narrow spaces behind furniture, radiators and around pipes
- Incorporates an elbow joint for angled cleaning
- Fits the telescopic handle for high-level cleaning
- Sleeves can be changed by room or area to reduce risk of cross-contamination
- Dual-sided (microfiber/strands).
- Large dirt particles/hair are trapped in the strands while the microfiber side gives the best cleaning performance on smooth surfaces
- For quick cleaning of awkward shapes such as stair rails, bed frames etc
- **Microfiber sleeve washable up to 1000 times**







Old Product Code	NEW Code	Product Description	Size	Pack	Application
SW8259	114476	20" Duo-duster frame	50.8 cm/ 20 in	1	  
SW8260	508378	20" Duo-duster refill	50.8 cm/ 20 in	1	  

## Microfiber Duster



- The micro-duster tool enables you to clean the hard to reach areas either by a hand held handle or it can be put on an extension handle.
- The duster tool can be bent to allow for better cleaning of fans or on top of cabinets etc.
- The refill sleeves are made with ultra fine 100% microfibers. Will remove and hold more dirt and bacteria than old traditional dusters.
- Micro-duster refills are designed to withstand repeated washing and sewn for superior strength.
- **Microfiber sleeve washable up to 500 times**



Old Product Code	NEW Code	Product Description	Size	Pack	Application
MF8500	135592	Microfiber duster holder		1	  
MF8501	135591	Microfiber duster sleeve refill		1	  

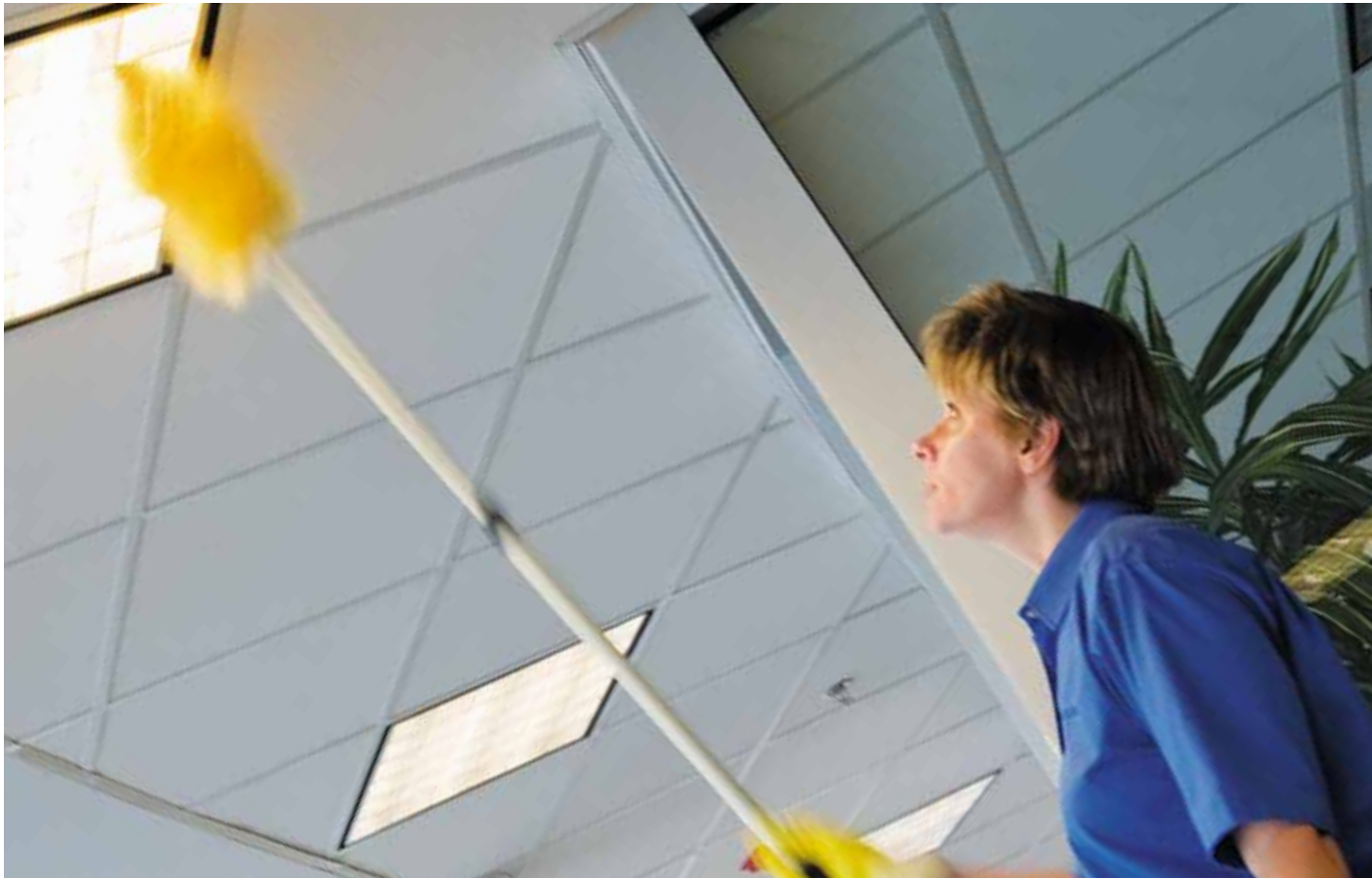









### Lambswool Dusters

- Lambswool dusters are ideal for all purpose dusting and are made from 100% lambswool.
- Lambswool is a natural fiber that requires no additional cleaning sprays. Its natural properties protects furniture from scratching and streaking.
- Dusters may be laundered with any mild soap.
- Available with telescopic handle for hard to reach places.

• Economical solution to your dusting needs









Old Product Code	NEW Code	Product Description	Size	Pack	Application
MI524	134772	24" Lambswool duster	61 cm/ 24 in	10	  
MI525	134773	42" Telescopic lambswool duster	107 cm/ 42 in	10	  
MI527	134774	61" Flexible lambswool duster with extra long telescopic handle	155 cm/ 61 in	10	  



## Rainbow Magnetic Dusters

Rainbow magnetic dusters attract dust with electrostatic action



- Ideal for all purpose dusting – vertical, venetian or mini blinds.
- Telescopic Duster is ideal for hard-to-reach places.
- Easy to clean with mild detergent.

Old Product Code	NEW Code	Product Description	Size	Pack	Application
DU05100	134613	Short Handle rainbow magnetic duster	69 cm/ 27 in	12	  
DU05102	134614	Telescopic magnetic duster	132 cm/ 52 in	12	  



## Ostrich Feather Dusters

- Ostrich feather dusters are made from the finest genuine ostrich feathers available.
- They are ideal for dusting objects that are delicate and fragile.

Old Product Code	NEW Code	Product Description	Size	Pack	Application
MI1224	134757	Supreme Ostrich feather duster	77 x 62 x 63 cm/ 30.31 x 24.41 x 24.8 in	10	  

# WINDOW CLEANING

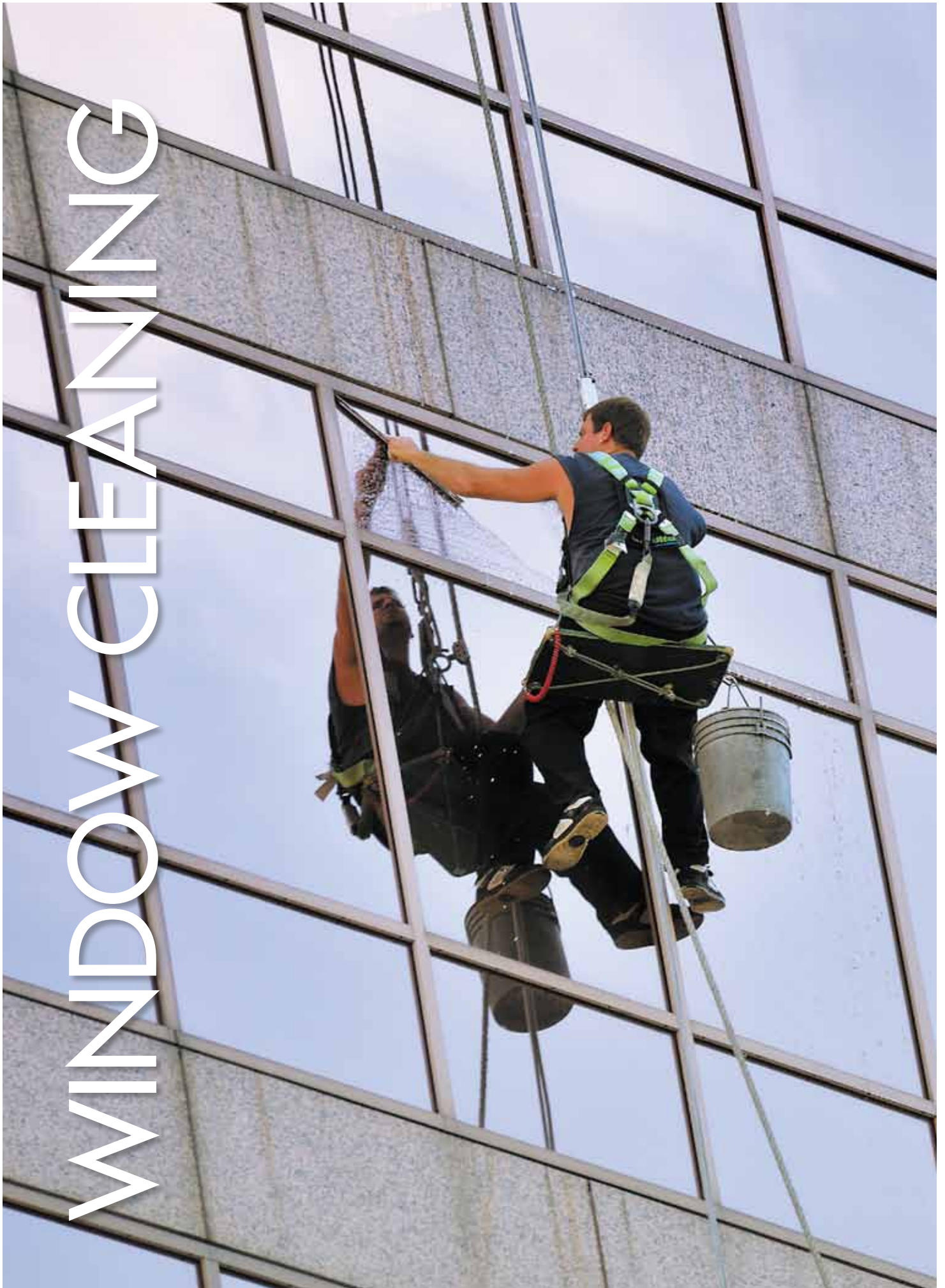

## Window Cleaning



### Brass Squeegee Handle



- The best choice
- Rubber blade is secured in the channel by a clip at either end
- Tension of rubber blade can be adjusted
- Channel made of extra-stiff brass
- Channel is locked onto the handle by two screws

Old Product Code	NEW Code	Product Description	Size	Pack	Application
PUT60000	134951	Brass window squeegee handle	50 x 31 x 31 cm/ 19.69 x 12.20 x 12.20	10	  

### Swivel Squeegee Handle











- Swivel handle for use with the telescopic pole when cleaning tricky areas.

Old Product Code	NEW Code	Product Description	Size	Pack	Application
PUT86000	134959	Swivel squeegee handle	81 x 41 x 21 cm/ 31.89 x 16.14 x 8.27 in	10	  

### Brass Channel with Rubber



- The best choice
- Rubber blade is secured in the channel by a clip at either end
- Tension of rubber blade can be adjusted
- Channel made of extra-stiff brass
- Channel is locked onto the handle by two screws

Old Product Code	NEW Code	Product Description	Size	Pack	Application
PUT61230	139789	12" Brass channel with rubber and clips	30 cm/ 12 in	10	  
PUT61435	139790	14" Brass channel with rubber and clips	35 cm/ 14 in	10	  
PUT61845	139791	18" Brass channel with rubber and clips	45 cm/ 18 in	10	  





## Stainless Steel Squeegee Handle

- Ideal for cleaning flat, smooth surfaces, Pro Stainless-Steel Squeegees feature a Fast-Lock handle for quick blade and channel changes and a non-slip rubber grip for comfortable handling.
- Coin-adjustable screws can adjust the channel for desired tension.

Old Product Code	NEW Code	Product Description	Size	Pack	Application
PUT00600	134947	Stainless steel squeegee handle	50 x 32 x 31 cm/ 19.69 x 12.6 x 12.20 in	10	  



## Stainless Steel Channel with Rubber









- The professional choice
- Stainless steel construction
- Rubber blade is secured in the channel by a clip at either end
- Tension of rubber blade can be adjusted
- Channel is locked onto the handle by two screws

Old Product Code	NEW Code	Product Description	Size	Pack	Application
PUT01300	139792	12" Channel with rubber – stainless steel	30 cm/ 12 in	10	  
PUT01350	139793	14" Channel with rubber – stainless steel	35 cm/ 14 in	10	  
PUT01450	139794	18" Channel with rubber – stainless steel	45 cm/ 18 in	10	  



## Replacement Rubber Soft

- Real vulcanized natural rubber which is compressed and molded
- Optical and computerized control of blade edge for a sharp cutting resulting in a streak-free finish

Old Product Code	NEW Code	Product Description	Size	Pack	Application
PUT71230	139795	12" Replacement rubber	30 cm/ 12 in	10	  
PUT71435	139796	14" Replacement rubber	35 cm/ 14 in	10	  
PUT71845	139797	18" Replacement rubber	45 cm/ 18 in	10	  



## Clip for Squeegee

- Brass clip secures replacement rubber on brass channel

Old Product Code	NEW Code	Product Description	Size	Pack	Application
PUT70000	520033	Clip for brass window squeegee		1	  



## Plastic Squeegee Complete









- An economical alternative to our professional brass or stainless steel series.
- Extruded aluminum channel
- Lightweight
- Can be mounted on telescopic pole for high-up jobs
- Assembled and dis-assembled easily

Old Product Code	NEW Code	Product Description	Size	Pack	Application
PUS12030	134944	12" Plastic window squeegee complete	30 cm/ 12 in	10	  
PUS14035	134945	14" Plastic window squeegee complete	35 cm/ 14 in	10	  
PUS18045	134946	18" Plastic window squeegee complete	45 cm/ 18 in	10	  



## All Plastic T-Handle







- Plastic T-Handle is made entirely of plastic in a honeycomb design for maximum water retention.

Old Product Code	NEW Code	Product Description	Size	Pack	Application
PUV61025	135119	10" Plastic T- handle	25 cm/ 10 in	1	  
PUV61435	135121	14" Plastic T- handle	35 cm/ 14 in	1	  
PUV61845	135081	18" Plastic T- handle	45 cm/ 18 in	1	  



## Swivel Washer Handle





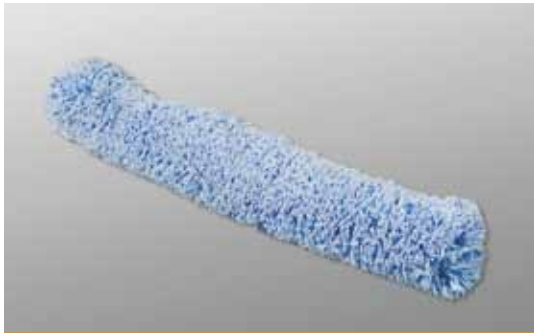

- Swivel washer handle is lightweight
- Aluminum bar

Old Product Code	NEW Code	Product Description	Size	Pack	Application
PUV71435	135118	14" Swivel window washer handle	35 cm/ 14 in	1	  
PUV71845	135117	18" Swivel window washer handle	45 cm/ 18 in	1	  



## Microfiber Replacement Sleeve









- Microfiber replacement sleeve can absorb 6 times its weight
- Able to withstand many washings

Old Product Code	NEW Code	Product Description	Size	Pack	Application
PUV94335	139798	14" Microfiber Replacement sleeve	35 cm/ 14 in	10	  
PUV94345	139799	18" Microfiber Replacement sleeve	45 cm/ 18 in	10	  



## Replacement Sleeve







- Fiber does not shed hairs
- Nap is specially shaped and hemmed to form a woven fiber sleeve with high water retention.
- Ends are reinforced to protect them against wear and tear

Old Product Code	NEW Code	Product Description	Size	Pack	Application
PUV81025	139800	10" Replacement sleeve	25 cm/ 10 in	10	  
PUV81435	139801	14" Replacement sleeve	35 cm/ 14 in	10	  
PUV81845	139802	18" Replacement sleeve	45 cm/ 18 in	10	  



## Replacement Sleeve with Abrasive Strip



- Fiber does not shed hairs
- Nap is specially shaped and hemmed to form a woven fiber sleeve with high water retention.
- Ends are reinforced to protect them against wear and tear
- Abrasive strip increases cleaning performance by scrubbing stubborn dirt.

Old Product Code	NEW Code	Product Description	Size	Pack	Application
PUV91435	139803	14" Replacement sleeve with abrasive strip	35 cm/ 14 in	10	  
PUV91845	139804	18" Replacement sleeve with abrasive strip	45 cm/ 18 in	10	  



## Handy Car / Window Squeegee

- Ideal for use in or around your home.
- Handy to put in your car.
- Gentle scrubber.
- Durable rubber squeegee.

Old Product Code	NEW Code	Product Description	Size	Pack	Application
WS09100	135058	10" Handy car/ window squeegee with tall handle	25 cm head with 50 cm Handle / 10 in head with 20 in Handle	10	  



## Holster



- Multi-purpose holster holds various size squeegees and washers.
- Stays wet and ready for use without dripping which means no more wet cloths.
- Detachable version snaps on and off the belt
- Made of extra resistant polypropylene that has three compartments for squeegees, channels and spares.

Old Product Code	NEW Code	Product Description	Size	Pack	Application
PUW04010	134978	Tubex holster – detachable	30 cm/ 12 in	10	  



## Scrapers













- All scrapers can be used on windows, floors and various surfaces
- All scrapers come with ABS plastic blade covers to be fitted over the blade for safety.
- Plastic handle is 5.5" long and is suitable for handheld use.
- Aluminum handle is 48" long and is suitable for long-range scrapping on high or out of reach surfaces.
- All scrapers come with ABS plastic blade covers to be fitted over the blade for safety.
- Plastic handle is 5.5" long and is suitable for handheld use.
- Aluminum handle is 48" long and is suitable for long-range scrapping on high or out of reach surfaces.

Old Product Code	NEW Code	Product Description	Size	Pack	Application
PUR01510	139805	5.5" Scraper with plastic handle	14 cm/ 5.5 in	10	  
PUR01530	134941	48" Scraper with aluminum handle	120 cm/ 48 in	10	  



## Floor Scrapers and Blades

- Glass blades with reversible razor sharp edge
- Glass stainless steel scraper holder fits squeegee handle.
- Hand held razor holder locks to secure razor in place

Item	Old Product Code	NEW Code	Product Description	Size	Pack	Application
1	PUR01555	134942	Safety scraper blade holder	25 x 21 x 18 cm/ 9.84 x 8.27 x 7.09 in	1	  
2	PUR01560	134943	Safety scraper blades – 100 pack	25 x 21 x 18 cm/ 9.84 x 8.27 x 7.09 in	100	  
3	PUR00303	139806	Special blades for floor scraper	10 cm/ 4 in	200	  
4	PUR00305	134939	Dispenser with 10 blades for scraper	10 cm/ 4 in	100	  



## Telescopic poles in two or three pieces

- Extruded aluminum tubes are coupled together by means of nylon collars.
- The end of each pole has a standard or screw cone on which you can mount any tools – squeegee, washer, cobweb brush or scraper

Old Product Code	NEW Code	Product Description	Size	Pack	Application
PUP02250	135140	8' Telescopic pole in 2 pieces	250 cm/ 8 ft	1	  
PUP02400	135139	13' Telescopic pole in 2 pieces	400 cm/13 ft	1	  
PUP03450	135138	15' Telescopic pole in 3 pieces	450 cm/ 15 ft	1	  
PUP03600	135137	20 Telescopic pole in 3 pieces	600 cm/ 20 ft	1	  
PUP03900	135136	29' Telescopic pole in 3 pieces	900 cm/ 29 ft	1	  



## Telescopic Pole Holder

- The stand helps keep product neat and organized.
- Proper storage of product will protect against careless damaging, decrease replacement cost and extend the life of your products.
- By attractively displaying product, customers will be able to view product offered at a glance, therefore increasing sales.
- Ideal for displaying new products.

Old Product Code	NEW Code	Product Description	Size	Pack	Application
PUP06000	134937	Telescopic pole holder/base	47 x 45 x 18 cm/ 18.5 x 17.72 x 7.09 in	1	  



## Accessories for Telescopic Poles

- Standard screw type cone that allows you to mount multiple tools

Old Product Code	NEW Code	Product Description	Size	Pack	Application
PUP04105	135084	Threaded cone for telescopic pole		1	  

# WASTE



# Other Cleaning Tools

## **WASTE MANAGEMENT**      **120 – 127**

- Gladiator Containers
  - Plastic
  - Recycle
  - Accessories
- Gladiator Waste Baskets
  - Plastic
  - Recycle
- Miscellaneous
- Litter Scoops
  - Litter Picker
  - Nippers
  - Outdoor Ashtray

## **WASHROOM CARE**      **128 – 136**

- Odor Control
  - E-Mist Odor Control System
  - Gel Dispenser
  - Urinal Screens
  - Urinal Pucks
- Soap Dispensers
- Clearline
  - Nu-Line
  - Bowl Brushes
- Plunger
- Toilet Paper Dispenser
- Dual Paper Dispenser
- Napkin Disposal
- Sprayers
- Cleaners

# The Gladiator waste container is solid, heavy duty and extremely durable.

- Added strength around interior stacking shoulder which increases resistance and durability

- Built in ribbed vents allow for smooth removal of garbage bags thereby reducing the risk of back injuries



- Gladiator containers are reinforced for added strength and durability

- High impact plastic is crush resistant, rugged and long lasting

**Optional Dolly Locks into Base and provides additional support for heavier loads**



AVAILABLE IN



- Lock down lids snap securely in place allowing contents to remain within, in case container is overturned

- Gladiator rims are reinforced for added strength and durability



- Gladiator handles have increased wall thickness and are designed for easier lifting

- Colour is molded into the plastic. Will not chip, crack or peel

- Built-in wheel assembly base (**5 wheels optional**)

- Base is reinforced to provide greater stability and weight distribution when dragging over any surface





# Gladiator Containers



Gladiator waste containers are ideal for collecting trash, cleaning the garage, working in the yard and garden, or storing items. The snap-on lid provides a secure locking feature to lock in odors and lock out rodents. The molded-in handles provide maximum strength and durability. In addition, the optional castors take the strain of lifting heavy loads.

## Four options to meet your needs



Container

Container & Lid































Container & Wheels

Container & Dolly





Please refer to page 137 for Private Label Program



## Gladiator Waste Containers

Old Product Code	NEW Code	Product Description	Size	Pack	Application
GB2020G	134664	Garbage container, 76 L/ 20 gal – grey	57 h x 49 cm dia / 22.5 x 19.25 in dia	1	  
GB2020RD	134670	Garbage container, 76 L/ 20 gal – red	57 h x 49 cm dia / 22.5 x 19.25 in dia	1	  
GB2020WH	134671	Garbage container, 76 L/ 20 gal – white	57 h x 49 cm dia / 22.5 x 19.25 in dia	1	  
GB2020YE	134672	Garbage container, 76 L/ 20 gal – yellow	57 h x 49 cm dia / 22.5 x 19.25 in dia	1	  
GB3232G	134674	Garbage container, 121 L/ 32 gal – grey	69 h x 56 cm dia / 27.5 h x 22 in dia	1	  
GB3232RD	134681	Garbage container, 121 L/ 32 gal – red	69 h x 56 cm dia / 27.5 h x 22 in dia	1	  
GB3232WH	134682	Garbage container, 121 L/ 32 gal – white	69 h x 56 cm dia / 27.5 h x 22 in dia	1	  
GB3232YE	134683	Garbage container, 121 L/ 32 gal – yellow	69 h x 56 cm dia / 27.5 h x 22 in dia	1	  
GB4444G	134687	Garbage container, 167 L/ 44 gal – grey	80 h x 61 cm dia / 31.5 h x 24 in dia	1	  
GB4444RD	134693	Garbage container, 167 L/ 44 gal – red	80 h x 61 cm dia / 31.5 h x 24 in dia	1	  
GB4444WH	134694	Garbage container, 167 L/ 44 gal – white	80 h x 61 cm dia / 31.5 h x 24 in dia	1	  
GB4444YE	134695	Garbage container, 167 L/ 44 gal – yellow	80 h x 61 cm dia / 31.5 h x 24 in dia	1	  

## Gladiator Waste Containers Lids

Old Product Code	NEW Code	Product Description	Size	Pack	Application
GB2020LG	134666	Garbage container lid, 76 L/20 gal – grey	57 h x 49 cm dia / 22.5 x 19.25 in dia	1	  
GB2020LRD	134667	Garbage container lid, 76 L/20 gal – red	57 h x 49 cm dia / 22.5 x 19.25 in dia	1	  
GB2020LWH	134668	Garbage container lid, 76 L/20 gal – white	57 h x 49 cm dia / 22.5 x 19.25 in dia	1	  
GB2020LYE	134669	Garbage container lid, 76 L/20 gal – yellow	57 h x 49 cm dia / 22.5 x 19.25 in dia	1	  
GB3232LG	134676	Garbage container lid, 121 L/32 gal – grey	69 h x 56 cm dia / 27.5 h x 22 in dia	1	  
GB3232LRD	134677	Garbage container lid, 121 L/32 gal – red	69 h x 56 cm dia / 27.5 h x 22 in dia	1	  
GB3232LSW	135636	Garbage container swing lid, 121 L/32 gal – grey	69 h x 56 cm dia / 27.5 h x 22 in dia	1	  
GB3232LWH	134679	Garbage container lid, 121 L/32 gal – white	69 h x 56 cm dia / 27.5 h x 22 in dia	1	  
GB3232LYE	134680	Garbage container lid, 121 L/32 gal – yellow	69 h x 56 cm dia / 27.5 h x 22 in dia	1	  
GB4444LG	134689	Garbage container lid, 167 L/44 gal – grey	80 h x 61 cm dia / 31.5 h x 24 in dia	1	  
GB4444LRD	134690	Garbage container lid, 167 L/44 gal – red	80 h x 61 cm dia / 31.5 h x 24 in dia	1	  
GB4444LWH	134691	Garbage container lid, 167 L/44 gal – white	80 h x 61 cm dia / 31.5 h x 24 in dia	1	  
GB4444LYE	134692	Garbage container lid, 167 L/44 gal – yellow	80 h x 61 cm dia / 31.5 h x 24 in dia	1	  



## Gladiator Recycled Plastic Containers

- Added strength around interior stacking shoulder for increased durability.
- Containers are reinforced for added strength and durability.
- High impact plastic is crush resistant, rugged and long lasting.
  - Colour is molded into the plastic.
  - Will not chip, crack or peel.
  - Built-in wheel assembly base (wheels optional).
  - Recycled lid with hole in centre for cans etc.
  - Please refer to page 137 for Private Label Program



Old Product Code	NEW Code	Product Description	Size	Pack	Application
GB2020-BL-RYC	134663	Blue recycling container, 76 L/ 20 gal	57 h x 49 cm dia / 22.5 x 19.25 in dia	1	
GB3232-BL-RYC	134673	Blue recycling container, 121 L/ 32 gal	69 h x 56 cm dia / 27.5 h x 22 in dia	1	
GB4444-BL-RYC	134686	Blue recycling container, 167 L/ 44 gal	80 h x 61 cm dia / 31.5 h x 24 in dia	1	
GB2020L-BL01	134665	Blue lid with hole, 76 L/ 20 gal	57 h x 49 cm dia / 22.5 x 19.25 in dia	1	
GB3232L-BL01	134675	Blue lid with hole, 121 L/ 32 gal	69 h x 56 cm dia / 27.5 h x 22 in dia	1	
GB4444L-BL01	134688	Blue lid with hole, 167 L/ 44 gal	80 h x 61 cm dia / 31.5 h x 24 in dia	1	
GB2020L-BL	136408	Garbage Lid – Blue, 76 L/ 20 gal	57 h x 49 cm dia / 22.5 x 19.25 in dia	1	
GB3232L-BL	136216	Garbage lid – Blue, 121 L/ 32 gal	57 h x 49 cm dia / 22.5 x 19.25 in dia	1	
GB4444L-BL	136217	Garbage lid – Blue, 167 L/ 44 gal	57 h x 49 cm dia / 22.5 x 19.25 in dia	1	



## Gladiator Dolly

- Gladiator Dolly locks into base and provides additional support for heavier loads.
- Fits most competitor's containers

Old Product Code	NEW Code	Product Description	Size	Pack	Application
GB4000	134684	Gladiator Dolly for 76 L, 121 L, 167 L / 20 gal, 32 gal, 44 gal containers	46 x 46 x 23 cm / 18.11 x 18.11 x 9.06 in	2	



## Gladiator Caddy

- Caddy fits all Gladiator container
- Quick installation
- Apron-like design allows for accessories to be inserted into pockets of various sizes for easy of transportation
- Fits most competitor's containers



Old Product Code	NEW Code	Product Description	Size	Pack	Application
GB4001	134685	Caddy for 76 L, 121 L, 167 L / 20 gal, 32 gal, 44 gal containers	91 x 33 x 29 cm / 35.82 x 12.99 x 11.42 in	1	
MA909-D	519846	Gladiator Dolly wheels – one only		1	
MA909-G	519847	Gladiator container wheels – one only		1	

## Gladiator Waste Baskets

- Waste baskets are ideal for centralized recycling. They fit perfectly against a desk or wall and can be used for collecting waste or recycling
- Easy to clean – no dirt traps
- Please refer to page 137 for Private Label Program



Item	Old Product Code	NEW Code	Product Description	Size	Pack	Application
1	WB1313-BK	135012	Waste basket, Small – black	13 L/ 13.7 qt	12	  
2	WB2815-BE	135013	Waste basket, Medium – beige	26 L/ 28 qt	12	  
2	WB2815-BK	135014	Waste basket, Medium – black	26 L/ 28 qt	12	  
2	WB2815-GR	135016	Waste basket, Medium – grey	26 L/ 28 qt	12	  
3	WB4120-BE	135017	Waste basket, Large – beige	39 L/ 41 qt	12	  
3	WB4120-BK	135018	Waste basket, Large – black	39 L/ 41 qt	12	  
3	WB4120-GR	135020	Waste basket, Large – grey	39 L/ 41 qt	12	  

## Gladiator Waste Baskets / Garbage Containers

The low profile and sleek design of these rectangular waste/baskets make them the right choice for a variety of applications ranging from classroom, office, commercial or institutional use

- High impact plastic is crush resistant, rugged and long lasting.
- Colour is molded into the plastic. Will not chip, crack or peel.
- Optional swing lid.

Please refer to page 137 for Private Label Program



Old Product Code	NEW Code	Product Description	Size	Pack	Application
SP2330-BE	134990	Waste basket – beige	87 L/ 23 gal	4	  
SP2330-BK	134991	Waste basket – black	87 L/ 23 gal	4	  
SP2330-GR	134993	Waste basket – grey	87 L/ 23 gal	4	  
SP2330-SL-BE	134994	Waste basket swing lid – beige	87 L/ 23 gal	4	  
SP2330-SL-BK	134995	Waste basket swing lid – black	87 L/ 23 gal	4	  
SP2330-SL-GR	134997	Waste basket swing lid – grey	87 L/ 23 gal	4	  



## Gladiator Recycled Waste Basket/Containers

Made for recycling of a variety of products: paper and cardboard, glass and bottles, containers for food products, polystyrene and other plastic materials, food tins, soft drink cans, beer caps, aluminum paper and plates and metal lids.

- Space efficient bin that is ideal for desk side waste and recycling.
- Optional swing lid.
- Please refer to page 137 for Private Label Program



Old Product Code	NEW Code	Product Description	Size	Pack	Application
SP2330-BL-RYC	134992	Recycling waste basket – blue	87 L/ 23 gal	4	
SP2330-SL-BL	134996	Recycling waste basket swing lid	87 L/ 23 gal	4	
WB2815-BL-RYC	135015	Recycling waste basket, Medium – blue	23 x 28 x 33 cm/ 9 x 11 x 13 in	12	
WB4120-BL-RYC	135019	Recycling waste basket, Large – blue	39 L/ 41 qt	12	



## Litter Scoops And Pick Ups

- Our heavy duty litter bag and metal hoop is indispensable in a variety of situations – for cleaning exterior public areas or in and around schools.
- Please order both (2) components for a complete unit

Old Product Code	NEW Code	Product Description	Size	Pack	Application
FR1171-1	135523	Litter scoop hoop only	80 x 42 x 14 cm/ 31.5 x 16.54 x 5.51 in	1	
FR1171-500	135522	Litter scoop bag only	81.3 x 81.3 cm/ 32 x 32 in	1	

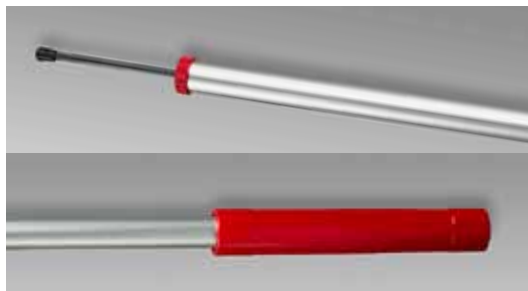

## Litter Scoops And Pick Ups

- Our sticker rods are ideal for picking up waste by avoiding manual contact with rubbish or toxic substances

Old Product Code	NEW Code	Product Description	Size	Pack	Application
PUW02300	135109	Litter picker spike – fixed point aluminum handle		1	



## Nippers

- The ideal way of picking up, positioning and removing items without requiring ladders.
- Cleaning public areas and garden, washing urinals and toilets, collecting industrial products and waste or arranging things on shelves.
- Light compression of handle to give maximum gripping pressure

Old Product Code	NEW Code	Product Description	Size	Pack	Application
PUW02100	135110	Nipper	101.6 cm/ 40 in	1	  
PUZ88100	134982	Nipper plastic tips – set of 2 ea		10	  





## Heavy Duty Outdoor Ashtray Bin

The heavy duty stainless steel ash bin is ideal for outdoor pedestrian common areas.

- Heavy duty stainless steel with brushed finish
- Secured with tumbler keyed lock
- Door is hinged with full length stainless steel piano hinge
- Corrosion resistant galvanized steel inner liner with baffle opening
- Offset mounting bracket



- Includes liner

Old Product Code	NEW Code	Product Description	Size	Pack	Application
WC909	135025	Outdoor ashtray, heavy duty, stainless steel		1	  

# WASHROOM CARE









## E-Mist Odor Control System

Economical metered odor control system. Ideal for any environment.

### Features

- Programmable spray release – approx. 3400 spray applications.
- Quick and easy to install on any tile or wall surface.
- Once unlocked, front panel drops down for easy replacement of aerosols.
- Key-lock prevents tampering

Old Product Code	NEW Code	Product Description	Size	Pack	Application
AD-330E	134440	E-Mist odor control system	47 X 33 X 50 cm/ 18.5 x 12.99 x 19.69 in	1	  



## Air Deodorizer

Adds a light, fresh scent to your public washrooms, home or place of business. Contains odor counteractant



- Refills for AD-300E/134440 see above

Old Product Code	NEW Code	Product Description	Size	Pack	Application
07902	134385	Green Apple air deodorizer	27.5 x 20 x 15.5 cm/ 10.83 x 7.87 x 6.10 in	12	  
07905	134386	Citrus air deodorizer	27.5 x 20 x 15.5 cm/ 10.83 x 7.87 x 6.10 in	12	  
07908	134387	Linen air deodorizer	27.5 x 20 x 15.5 cm/ 10.83 x 7.87 x 6.10 in	12	  
07909	134388	Rain air deodorizer	27.5 x 20 x 15.5 cm/ 10.83 x 7.87 x 6.10 in	12	  



## Gel Dispenser and Refills

Wall mounted and attractively designed, these units fit beautifully in today's modern environments. Light sensitive photo electric eye turns unit on and off which saves battery life and money. Blinking LED light indicates whether unit is working and battery needs replacement. Air Fresh Dispensers provide a fresh, fragrant atmosphere 24 hours a day.

- Durable construction made of virtually unbreakable ABS plastic.
- Provides 24 hours of odor control for up to 30 days.
- Designed for convenient quick change of batteries and fragrance cup.
- Can be set in automatic or manual (on/off) mode.
- One unit will control odors up to 100 cubic meters / 3500 cubic feet.
- Refer to page 130 for refills

Old Product Code	NEW Code	Product Description	Size	Pack	Application
AF-180M	135604	Air freshener with light and LED sensor	10 x 8.5 x 26 cm/ 3.93 x 3.35 x 10.24 in	1	  

## Gel Refills



Air Fresh Dispensers provide a fresh, fragrant atmosphere 24 hours a day.

- Each fragrance cup is sealed and wrapped in a clear plastic film to ensure full strength of scent at time of usage.
- Refills for AF-180M / 135604 dispenser refer to page 129



Old Product Code	NEW Code	Product Description	Size	Pack	Application
AF09101	134441	Air freshener gel refill – cherry scent	44 X 29 X 22 in/ 17.32 X 11.42 X 8.66 in	12	
AF09102	134442	Air freshener gel refill – apple scent	44 X 29 X 22 in/ 17.32 X 11.42 X 8.66 in	12	
AF09105	134443	Air freshener gel refill – citrus scent	44 X 29 X 22 in/ 17.32 X 11.42 X 8.66 in	12	



## Urinal Screens With Block

Protect your pipe work, fixture or fitting from costly maintenance and time consuming cleaning with this easily disposable urinal screen with block. Simply place plastic screen with open end against centre of urinal. That's it! Upon flushing the urinal, the water dissolves a portion of the waxy composition contained in the block, releasing its bacteriostatic ingredients and refreshing scent.

- Long lasting . . . a minimum of 30 days.
- Complete screen and chemical block bonded together.
- Automatically cleans, descales, deodorizes with every flush.
- Specially formulated to prevent waste build-up.

Old Product Code	NEW Code	Product Description	Size	Pack	Application
CU30	134523	Uni tab urinal screen with lavender scented puck	60 X 40 x 43 cm/ 23.62 x 15.75 x 24.8 in	12	
CU40	134524	Urinal screen with non-para apple scented block	70 x 40 x 43 cm / 27.56 x 15.75 x 16.93 in	12	
MIUS-1	134798	Urinal screen – cherry scent	44 X 25 x 25 cm/ 17.3 x 10 x 10 in	50	
MIUS-2	134799	Urinal screen – bubble gum scent	44 X 25 x 25 cm/ 17.3 x 10 x 10 in	50	

## Urinal Pucks And Blocks



- Eliminates all odors on contact
- Very effective and economical
- Block is air-soluble so flushes will not effect life of block
- 4 ounces, lasts 30-60 days
- Individually wrapped

Old Product Code	NEW Code	Product Description	Size	Pack	Application
06411	134383	Dichlorobenzene urinal puck – cherry	85 g/ 3 oz	12	
06412	134384	Dichlorobenzene urinal puck – cherry	113 g/ 4 oz	12	



## Clearline Soap Dispenser

A new transparent designer soap dispenser that's perfect for any kitchen or bathroom!

The Clearline soap dispenser features a unique decorative design that does not leak and is highly durable.

The smooth push button design dispenses the right amount of soap with every stroke and is convenient while bathing or washing hands

- Key-lock prevent tampering
- Quick and easy to install on any tile or plastic wall surface
- Refillable container. Fill with your choice of bulk soap.
- No clogging or leaking.
- Stands up to heavy use.
- **Installation required**
- **Hardware included**

Old Product Code	NEW Code	Product Description	Size	Pack	Application
SD-500	134989	Clearline soap dispenser	900 ml	12	  



## Nu-Line Bulk Soap Dispenser

Soap dispenser systems are fast becoming the preferred method of hand washing. These dispensers can be filled with a variety of liquids such as hand soap, body cleansers, shampoos, and more. They are attractively designed and are made of virtually unbreakable ABS plastic. Unlike the pull style dispensers, the push style has no pull tab lever which breaks and the push design prevents dispenser from being pulled off the wall.

- Double case design to accept most cartridge systems.
- Bulk loading of soap or patented cartridge loading.
- Strong durable construction that protects against vandalism.
- Push style construction has longer life expectancy.



Old Product Code	NEW Code	Product Description	Size	Pack	Application
SD400	135090	Nu-Line Bulk Soap Dispenser	900 ml/ 11.42 qt capacity	1	  
SD400NIPPLE	134987	Soap dispenser nipple – only for SD400 / 135090		1	  
SD400R	520065	Soap dispenser refill		1	  



## Bowl Brushes

- Bowl brushes are contoured to facilitate scrubbing and cleaning of toilet bowl and under rim.
- These brushes are made of Polypropylene fiber that is staple set into a plastic handle.
- Plastic holder is optional and allows for easy upright storage.
- Twisted wire bowl brush is made from twisted wire and nylon fiber fill with a plastic hang up handle.

Old Product Code	NEW Code	Product Description	Size	Pack	Application
MI202	134759	Bowl brush with twisted wire centre	52 x 46 x 54 cm/ 20.47 x 18.11 x 21.26 in	24	  
MI203	134760	Plastic bowl brush and caddy	9 x 5 x 45 cm/ 3.54 x 1.97 x 17.72 in	24	  
MI204	134761	Plastic bowl brush	34 x 26 x 42 cm/ 13.39 x 10.24 x 16.54 in	24	  
MI204C	134762	Plastic bowl caddy only		24	  



## Acrylic Bowl Swab Brushes

- Economical bowl swab is made from the finest acid resistant acrylic yarn securely attached to a strong plastic handle.
- Acrylic material releases liquid quickly therefore eliminates dripping and is fast drying.
- Optional squeeze cup allows you to wring out the acrylic swab quickly without ever touching the puff.
- Self wiping cone.
- Cone slides over mop head and is squeezed to remove excess liquids.
- Acid resistant polypropylene strands.



Old Product Code	NEW Code	Product Description	Size	Pack	Application
MI209	134764	Acrylic bowl swab	47 x 38 x 16 cm/ 18.5 x 14.96 x 6.30 in	100	  
MI210	134765	Acrylic bowl swab with cup	47 x 38 x 16 cm/ 18.5 x 14.96 x 6.30 in	100	  

## Caddy



- Locking strap holds bottle snugly.
- Hinged lid keeps bowl mop hidden.
- Comfortable carrying handle.
- Conveniently holds quart bottle and bowl mop.
- Bottle and trigger sprayer not included





Old Product Code	NEW Code	Product Description	Size	Pack	Application
MI220	134766	Bowl brush caddy	46 x 39 x 33 cm/ 18.11 x 15.35 x 12.99 in	12	  

## Plunger



- Rubber cup provides a snug fit to all types of sinks, drains and toilet.
- Its strong suction allows for the movement of all types of stoppages.
- Colour: Anodized aluminum

Old Product Code	NEW Code	Product Description	Size	Pack	Application
PL2025	134930	Plunger with handle	47 X 20 X 24 cm/ 18.5 x 7.87 x 9.45 in	12	  

## Toilet Paper Dispensers



- Free rolling of tissue.
- Steel construction.
- Holds one or two standard 1-1/2" core toilet tissue rolls.

Old Product Code	NEW Code	Product Description	Size	Pack	Application
WC146	135612	Toilet paper dispenser – single roll	16 x 18 x 11 cm/ 6.375 x 3.87 x 4.25 in	1	  
WC150	135611	Toilet paper dispenser – double roll	32 x 8 x 1 cm/ 12.625 x 3.125 x 4.25 in	1	  





## Dual Paper Dispenser

### For single fold and rolls

- Our dual paper dispenser features a universal towel dispenser that will accept all standard single fold and roll towels (max. 15 cm / 6 inch diameter and up to 25 cm / 10 inch long).
- Available with a keyed tumbler lock to reduce theft and vandalism.
- Front loading for easy service and maintenance.
- All welded steel construction with full length piano hinge and tooth cutting edge.



- Includes wall mount







Old Product Code	NEW Code	Product Description	Size	Pack	Application
WC101	135613	Dual paper towel dispenser	58 x 58 x 28 cm/ 22.83 x 22.83 x 11.02 in	1	  



## Napkin Disposal

- White metal, noncorrosive sanitary napkin disposal receptacle features a top lid up for convenient disposal.



Old Product Code	NEW Code	Product Description	Size	Pack	Application
H260	134696	Waxed paper liners with gusset	19 x 9 x 26 cm/ 7.5 x 3.5 x 10.25 in	500	  
WC620	135610	Napkin disposal, metal – white	45 x 42 x 37 cm/ 17.72 x 16.54 x 14.57 in	1	  

## Sprayers and Cleaners

### Trigger Sprayers



- Our multipurpose, heavy duty trigger sprayers meet all your various needs — and are resistant to most solvents
- All sprayers are adjustable to provide fine mist to a steady stream.
- Heavy duty high output sprayer has a 3.5 ml per stroke output

Old Product Code	NEW Code	Product Description	Size	Pack	Application
TS5911-8	135008	Multi purpose sprayer, 8" dip tube – red/white	20 cm/ 8 in	200	
TS5911-9	135009	Multi purpose sprayer, 9" dip tube – red/white	23 cm/ 9 in	200	
TS5912-9	135010	Multi purpose sprayer, dip tube – blue/white	23 cm/ 9 in	200	
TS7700-9	135011	High output sprayer, dip tube – green/ white	23 cm/ 9 in	200	

### Trigger Sprayer Bottles



- Our trigger sprayers and bottles meet all your needs — multipurpose, heavy duty, and resistant to most solvents.
- All bottles are blow molded from high density polyethylene and are available in two sizes, 852 ml and 1137 ml / 24 oz and 32 oz, to meet different needs.



Please refer to page 137 for Private Label Program

Old Product Code	NEW Code	Product Description	Size	Pack	Application
TS289	135002	24 oz Round bottle	852 ml/ 24 oz	200	
TS289W	135004	24 oz Round bottle with WHMIS label	852 ml/ 24 oz	200	
TS290	135005	32 oz Round bottle	1137 ml/ 32 oz	141	
TS290W	135007	32 oz Round bottle with WHMIS label	1137 ml/ 32 oz	141	

## Chemicals



### Spray Nine®

- Spray Nine® cleans hard surfaces such as stainless steel, plastic, tile, rubber, vinyl, fiberglass, porcelain and formica with “spray-on/wipe-off” ease. Use to disinfect and deodorize hospitals, nursing homes, schools, and other institutions where housekeeping is of prime importance, when used as directed. Hospitals, schools, and institutions – to clean and disinfect non-wood floors, painted (enamel) walls, vinyl, and metal furniture, kitchens and bathrooms. Also use to spot clean carpets, bedding and uniforms.
- Spray Nine® cleans and disinfects! Spray Nine® not only cleans better and faster than ordinary household cleaners — it also kills household germs in record time. In fact, Spray Nine has been certified by the Environmental Protection Agency (EPA) to kill the following organisms on inanimate surfaces in just 30 seconds: HIV - 1 Virus (associated with AIDS), Salmonella, Staphylococci, Pseudomonas. Used regularly, Spray Nine® greatly reduces the risk of cross infection!
- Biodegradable, non-flammable, solvent free and ready to use.

Old Product Code	NEW Code	Product Description	Size	Pack	Application
61000	134418	Spray Nine trigger - small	650 ml/ .687 qt	6	  
61001	134419	Spray Nine jug	4 L/ .880 gal	4	  
61003	134420	Spray Nine trigger - large	946 ml/ 1 qt	12	  



## Private Label

# Why Branding is Important

## Your brand is your corporate identity.

### Private labeling enables...

- your customers to remember your product-service.
- you to build customer loyalty and leads to repeat purchases.
- your current clients or customers to refer you to others.
- you to add value to your brand



The Vileda Professional – Marino Private Label Program helps create a personalized and unique brand for you or your customers. This unique identity can build value and recognition as well as differentiate your products from your competitors' products.

Using our custom process, we can now put you or your company in the forefront of your clients to maximize your image and help prevent theft.

**Contact your representative for details.**



**INDEX**

Old Product Code	NEW Code	Page	Old Product Code	NEW Code	Page	Old Product Code	NEW Code	Page
06411	134383	130	AB226S	134432	83	CL1603	102562	106
06412	134384	130	AB226VWT	134433	83	CL42100	102751	106
07000	134421	66	AB228P	134434	81	CL7400-16	135348	44
07902	134385	129	AB229HWT	134435	84	CL7400-18	131591	44
07905	134386	129	AB229RP	134436	84	CMN1202	134518	15
07908	134387	129	AB300AR	134437	82	CMN1602	134519	15
07909	134388	129	AB300F	134438	82	CMN2002	134520	15
60306	134405	85	AB302B	134439	82	CMN2402	134521	15
60307	134406	85	AD-330E	134440	129	CMN3202	134522	15
60400	134407	89	AF09101	134441	130	CU30	134523	130
60401	134408	89	AF09102	134442	130	CU40	134524	130
60501	134409	86	AF09105	134443	130	DM1216	134525	32
60504	134410	86	AF-180M	135604	129	DM1216F	134526	32
60707	135585	85	BR1037	134445	86	DM1216-FH378EX	134527	32
60709	135584	85	BR1037S	134446	86	DM1216R	134528	32
60712	134415	85	BR216RB18	134447	64	DM518C	134529	30
60803	134416	72	BR216RB24	134448	64	DM518GB	134530	30
60804	134417	72	BR216RB36	134449	64	DM518GR	134531	30
61000	134418	136	BR217BF18	134450	64	DM518NB	134532	29
61001	134419	136	BR217BF24	134451	64	DM518NG	134533	29
61003	134420	136	BR217BF36	134452	64	DM518NR	134534	29
120119	120124	104	BR218HB18	134453	65	DM524C	134535	30
120120	120129	104	BR218HB24	134454	65	DM524GB	134536	30
120121	120130	104	BR219SF18	134455	63	DM524GR	134537	30
120122	120131	104	BR219SF24	134456	63	DM524NB	134538	29
120763	120763	91	BR219SF36	134457	63	DM524NG	134539	29
120766	120766	91	BR220T14CT	134458	62	DM524NR	134540	29
120769	120769	91	BR220T18	134459	63	DM524NY	134541	29
122583	122583	105	BR220T18CT	134460	62	DM536C	134542	30
125948	125948	43	BR220T24	134461	63	DM536GB	134543	30
125948	125948	94	BR220T24CT	134462	62	DM536GR	134544	30
127032	513233	96	BR220T36	134463	63	DM536NB	134545	29
127033	514010	96	BR221P18	134464	64	DM536NG	134546	29
127373	127375	105	BR221P24	134465	64	DM536NR	134547	29
128600	128604	103	BR221P36	134466	64	DM536NY	134548	29
128601	128605	103	BR222M18	134467	63	DM548C	134549	30
128602	128606	103	BR222M24	134468	63	DM548GB	134550	30
128603	128607	103	BR222M36	134469	63	DM548GR	134552	30
129406	129420	104	BR224G14CT	134470	62	DM548NB	134553	29
129407	129421	104	BR224G18	134471	65	DM548NG	134554	29
129408	129422	104	BR224G18CT	134472	62	DM548NR	134555	29
129409	129423	104	BR224G24	134473	65	DM548NY	134556	29
129459	129459	105	BR224G24CT	134474	62	DM560C	134557	30
133622	133642	104	BR224G36	134475	65	DM560GB	134558	30
133628	133645	104	BR4318B	135469	66	DM560GR	134559	30
133640	133646	104	BR4318G	135468	66	DM560NB	134560	29
133641	133647	104	BR4318R	135467	66	DM560NG	134561	29
133878	133878	51	BR4318Y	135466	66	DM560NR	134562	29
133879	133879	51	BR4324B	135465	66	DMBA518C	134563	27
136020	136020	52	BR4324G	135464	66	DMBA518NB	134564	26
136021	136021	52	BR4324R	135463	66	DMBA518NG	134565	26
136022	136022	51	BR700BL18	134483	61	DMBA524C	134567	27
137560	137560	51	BR700BL24	134484	61	DMBA524NB	134568	26
137561	137561	51	BR700RB18	134485	61	DMBA524NR	134570	26
137573	137573	37	BR700RB24	134486	61	DMBA536C	134572	27
137574	137574	37	BR700SBP16	134487	62	DMBA536NB	134573	26
138126	138126	93	BR700SR18	134488	61	DMBA536NG	134574	26
138129	138129	93	BR700SR24	134489	61	DMBA536NR	134575	26
138140	138140	93	BU1013	134490	54	DMBA548C	134576	27
138800	138800	93	BU10721W	134491	57	DMBA548NB	134577	26
138841	138841	37	BU14G	134492	54	DMBA548NG	134578	26
138844	138844	37	CA1700BZ	134493	97	DMBA548NR	134579	26
509264	509264	36	CA1700BZ	134493	99	DMBA560NB	134580	26
509265	509265	36	CA1700Z	134494	97	DMBA560NG	134581	26
509266	509266	36	CA1701	134495	97	DMDDMC24	134582	30
512132	512132	41	CA1702	134496	97	DMDDMC36	134583	30
521793	521793	93	CA1703	134497	97	DMDDMC48	134584	30
10000CC	134389	79	CA1750	134498	99	DM-ME5001	134586	28
120763-C	134390	91	CA1752	134499	99	DM-ME5002	134587	28
120766-C	134391	91	CA1800	134500	98	DM-ME5003	134588	28
120769-C	134392	91	CA1800B	134501	98	DTCO518F	519714	31
127033-B	134393	96	CA1802	134502	98	DTCO524F	519715	31
2999F	519526	32	CA1850	134503	98	DTCO536F	519716	31
2999H	519527	32	CA1852	134504	98	DTCO548F	519717	31
2999R	134404	32	CA1900	134505	99	DTCO560F	519718	31
60702W	135586	85	CA1900W	134506	99	DTCO60	135353	31
60707-BT	134413	86	CB102	134507	69	DTCO60EXT	135389	31
AB205BB	134422	83	CB103	134508	69	DTEZ518F	519721	27
AB205RWT	134423	83	CB104	134509	69	DTEZ524F	519722	27
AB205VWT	134424	83	CB107	134510	69	DTEZ536F	519723	27
AB206M	134425	81	CB107C	134511	68	DTEZ548F	519724	27
AB206P	134426	81	CB108	134512	68	DTEZ60	135352	27
AB206T	134427	81	CB110	134513	68	DTSN518F	519726	31
AB207L	134428	81	CB111	134514	73	DTSN524F	519727	31
AB210LW	134429	84	CB112	134515	73	DTSN536F	519728	31
AB210SVV	134430	84	CB500	134516	68	DTSN548F	519729	31
AB226B	134431	83	CL101268	102505	32	DTSN560F	519730	31

Old Product Code	NEW Code	Page	Old Product Code	NEW Code	Page	Old Product Code	NEW Code	Page
DTSN60	135350	31	H260	134696	134	MI202	134759	132
DTSN60F	135349	31	HB10	135634	57	MI203	134760	132
DUO5100	134613	110	MA1011YE	134700	54	MI204	134761	132
DUO5102	134614	110	MA1132YE	519647	56	MI204C	134762	132
FFSILKY16	134615	18	MA1133YE	134702	54	MI206D	134763	78
FFSILKY20	134616	18	MA1232-40B	134704	53	MI206D	134763	78
FH336M	134617	77	MA1232-40G	134706	53	MI209	134764	132
FH348	134618	74	MA1232-40GPROLINK	134708	53	MI210	134765	132
FH348M	135386	75	MA1232-40Y	131580	53	MI220	134766	133
FH348T	134620	74	MA1232-40YPRISON	134709	53	MI35	519883	76
FH354MFUPC	134622	74	MA1232BL	134710	55	MI351-BLK	134768	66
FH354TUPC	134624	74	MA1232GR	134711	55	MI405P	134769	84
FH354UPC	134625	74	MA1232YE	134713	55	MI4216B	134770	48
FH354VVT	134626	74	MA1232YE-PR	134714	55	MI4216R	134771	48
FH360/UPC	134629	74	MA2603BL	134715	55	MI524	134772	109
FH360-118	134630	74	MA2603GR	134717	55	MI525	134773	109
FH360A	134631	76	MA2603YE	134718	55	MI527	134774	109
FH360EXT	135148	76	MA2633BL	134719	53	MI7003	134775	47
FH360FB	134633	75	MA2633GR	134721	53	MI7005	134777	47
FH360FG	134634	75	MA2633YE	131582	53	MI7007	134779	47
FH360FR	134635	75	MA2633YE-PRISON	134724	53	MI800	134781	77
FH360FY	134637	75	MA2640BL	134725	55	MI800H	134782	77
FH360M	136418	75	MA2640GR	134727	55	MI802	134784	77
FH360M	136418	77	MA2640YE	134729	55	MI806	134785	77
FH360MF-1	134638	74	MA614	134730	78	MI810	134787	77
FH360MFUPC	134639	74	MA715	134731	78	MI98AB-H	134789	72
FH360NTFB	134640	75	MA901L-BL	520499	56	MI99AB-H	134792	72
FH360NTFB	134640	89	MA901L-GR	520510	56	MI99AB-H	134792	72
FH360TFUPC	134641	74	MA901L-GR-BLANK	520511	56	MIE745	134793	106
FH372EX-NT	135365	76	MA901L-GR	520511	56	MIE747	134794	107
FH378EX	135364	76	MA901L-GR	520513	56	MIHSPI	134795	107
FH396MFT	135363	74	MA901R-BL	520514	56	MILN1020	135337	19
FM1232-IN	519765	56	MA901R-GR	520515	56	MISSS	134797	107
FR1171-1	135523	126	MA901R-GR-BLANK	520516	56	MIUS-1	134798	130
FR1171-500	135522	126	MA901R-YE	520518	56	MIUS-2	134799	130
FS185B	134648	88	MA902L	519837	56	MIUTPBLA	134800	107
FS225B	134649	88	MA902R	519838	56	MIUTPVWH	134801	107
FS30HB	134650	88	MA903L	519839	56	MP3P12	134807	17
FS55618	134651	87	MA903R	519840	56	MP3P12B	134808	17
FS55624	134652	87	MA904	519841	56	MP3P16	134809	17
FS55630	134653	87	MA906	520205	56	MP3P16B	134810	17
FS55636	134654	87	MA907	519843	56	MP3P16VL	136181	16
FS556R18	134655	88	MA908	520206	56	MP3P16VVB	134812	17
FS556R24	134656	88	MA909	520207	56	MP3P20	134813	17
FS556R30	134657	88	MA909-D	519846	124	MP3P20B	134814	17
FS556R36	134658	88	MA909-G	519847	124	MP3P20FT	134816	18
FS55724	134659	88	MA911	520208	56	MP3P20VL	136182	16
FS55736	134660	88	MA912	519849	56	MP3P20VVB	134817	17
FS9424R	134661	89	MA913	520210	56	MP3P24	134818	17
FS9440	134662	89	MA920	520211	56	MP3P24B	134819	17
FWHANDLE	135029	48	MB100LP	134732	71	MP3P24FTB	134821	18
GB2020-BL-RYC	134663	124	MB100LPH	134733	71	MP3P24VL	136183	16
GB2020G	134664	123	MB3000	134734	73	MP3P24VVB	134822	17
GB2020L-BL	136408	124	MB91ECH	134735	70	MP3P32	134823	17
GB3232L-BL	136216	124	MB93LVB	134736	70	MP3P32B	134824	17
GB4444L-BL	136217	124	MB9513	134738	70	MP3P32VL	136184	16
GB2020L-BLO1	134665	124	MB96E	134739	70	MP3P32VVB	134826	17
GB2020LG	134666	123	MF4009	134741	46	MP4PS12	134827	15
GB2020L-RD	134667	123	MF4018	131600	44	MP4PS12B	134828	15
GB2020L-VH	134668	123	MF4200	502245	45	MP4PS12VVB	134829	15
GB2020L-YE	134669	123	MF5018	131602	45	MP4PS16	134830	15
GB2020RD	134670	123	MF5518	134743	45	MP4PS16B	134831	15
GB2020-VH	134671	123	MF8500	135592	108	MP4PS16-VL	136286	16
GB2020-YE	134672	123	MF8501	135591	108	MP4PS16VVB	134833	15
GB3232-BL-RYC	134673	124	MH145W	134746	23	MP4PS16VVB	134834	15
GB3232G	134674	123	MH160F	134747	23	MP4PS20	134836	15
GB3232L-BLO1	134675	124	MH160FG	138522	23	MP4PS20B	134837	15
GB3232LG	134676	123	MH160FR	138523	23	MP4PS20FT	134838	17
GB3232L-RD	134677	123	MH160FY	138524	23	MP4PS20VL	136287	16
GB3232L-SV	135636	123	MH160M-60	134748	23	MP4PS20VVB	134839	15
GB3232L-VH	134679	123	MH160W	134749	23	MP4PS24	134841	15
GB3232L-YE	134680	123	MH7000A	134750	22	MP4PS24B	134842	15
GB3232RD	134681	123	MH7000EXT	131605	23	MP4PS24FT	134843	17
GB3232-VH	134682	123	MH7000EXT	131605	52	MP4PS24VL	136288	16
GB3232-YE	134683	123	MH7000F	134751	22	MP4PS24VVB	134845	15
GB4000	134684	124	MH7000F-54	134752	22	MP4PS32	134847	15
GB4001	134685	124	MH7000FG	136276	22	MP4PS32B	134848	15
GB4444-BL-RYC	134686	124	MH7000FG-54	136270	22	MP4PS32-VL	136289	16
GB4444G	134687	123	MH7000FR	136277	22	MP4PS32VVB	134849	15
GB4444L-BLO1	134688	124	MH7000FR-54	136271	22	MP4PSSL	134850	12
GB4444LG	134689	123	MH7000FY	136279	22	MP4PSSLW	134852	12
GB4444L-RD	134690	123	MH7000FY-54	136272	22	MP4PSML	134854	12
GB4444L-VH	134691	123	MH7000M-54	134753	22	MP4PSMLW	134856	12
GB4444L-YE	134692	123	MH7000M-BL	134754	22	MP4PSSL	134858	12
GB4444RD	134693	123	MH7000W-54	134755	22	MP4PSLW	134859	12
GB4444-VH	134694	123	MH7000W-60	134756	22	MP4PSXLW	134861	12
GB4444-YE	134695	123	MI1224	134757	110	MP5000CT	134863	18
			MI201AB	134758	71	MPLMCSL	134864	19

# INDEX

Old Product Code	NEW Code	Page	Old Product Code	NEW Code	Page	Old Product Code	NEW Code	Page
MPLMCSLWB	134866	19	PUT01450	139794	113	SW121841	121841	94
MPLMCSM	134867	19	PUT60000	134951	112	SW122554	122555	96
MPLMCSMVB	134869	19	PUT61230	139789	112	SW122572	122573	96
MPLMCSS	134870	19	PUT61435	139790	112	SW122574	122575	96
MPLMLBL	134871	10	PUT61845	139791	112	SW122578	122579	96
MPLMLBL-VL	136290	14	PUT70000	520033	113	SW123525	514792	96
MPLMLGR	134872	10	PUT71230	139795	113	SW127477	127477	96
MPLMLGR-VL	136218	14	PUT71435	139796	113	SW127479	127479	96
MPLMLOR	134873	10	PUT71845	139797	113	SW127481	127481	96
MPLMLOR-VL	136249	14	PUT86000	134959	112	SW7581	114427	40
MPLMLV-BL	134874	11	PUV61025	135119	114	SW7586-50	508420	40
MPLMLVBL-VL	136291	14	PUV61435	135121	114	SW7594-50	507593	40
MPLMLVGR	134876	11	PUV61845	135081	114	SW8259	114476	108
MPLMLVGR-VL	136298	14	PUV71435	135118	114	SW8260	508378	108
MPLMLVOR	134877	11	PUV71845	135117	114	SW8357	119967	35
MPLMLVOR-VL	136304	14	PUV81025	139800	115	SW8357	119967	41
MPLMM-BL	134878	10	PUV81435	139801	115	TL100	135597	79
MPLMMBL-VL	136292	14	PUV81845	139802	115	TL103	131621	79
MPLMMGR	134879	10	PUV91435	139803	115	TL105	131622	79
MPLMMGR-VL	136299	14	PUV91845	139804	115	TS289	135002	135
MPLMMOR	134880	10	PUV94335	139798	115	TS289W	135004	135
MPLMMOR-VL	136305	14	PUV94345	139799	115	TS290	135005	135
MPLMMWV-BL	131598	11	PUVW01130	131587	57	TS290W	135007	135
MPLMMWBL-VL	136293	14	PUVW01131	131585	57	TS5911-8	135008	135
MPLMMWGR	134882	11	PUVW01135	135343	57	TS5911-9	135009	135
MPLMMWGR-VL	136300	14	PUVW01140	135083	57	TS5912-9	135010	135
MPLMMWOR	134883	11	PUVW01143	134974	57	TS7700-9	135011	135
MPLMMWOR-VL	136306	14	PUVW01144	134975	57	US113970	508095	35
MPLMS-BL	134884	10	PUVW02100	135110	127	US113972	508097	36
MPLMSBL-VL	136294	14	PUVW02300	135109	126	US113998	113998	35
MPLMSGR	134885	10	PUVW04010	134978	116	US114002	508243	35
MPLMSGR-VL	136219	14	PUVW04010-C	136486	116	US114003-BL	508239	36
MPLMSOR	134886	10	PUVW20045	135534	88	US114006	114397	36
MPLMSOR-VL	136143	14	PUVW20055	135533	88	US114007	522101	38
MPLMSV-BL	134887	11	PUVW20075	135532	88	US114008	508248	34
MPLMSVBL-VL	136295	14	PJ288100	134982	127	US114010	508249	34
MPLMSVGR	134889	11	SB225P14	134983	65	US114011	508250	34
MPLMSVGR-VL	136301	14	SB225P14CT	134984	65	US114985	114985	35
MPLMSWOR	134891	11	SB225P16	134985	65	US115974	115974	36
MPLMSWOR-VL	136307	14	SD400	135090	131	US116444	116444	35
MPLMXL-BL	134893	10	SD400NIPPLE	134987	131	US122341	512403	36
MPLMXLBL-VL	136296	14	SD400R	520065	131	WB1313BK	135012	125
MPLMXLGR	134894	10	SD-500	134989	131	WB2815-BE	135013	125
MPLMXLGR-VL	136302	14	SM117600	126595	21	WB2815-BK	135014	125
MPLMXLOR	134895	10	SM117613	117612	21	WB2815-BL-RYC	135015	126
MPLMXLOR-VL	136308	14	SP2330-BE	134990	125	WB2815-GR	135016	125
MPLMXLV-BL	134896	11	SP2330-BK	134991	125	WB4120-BE	135017	125
MPLMXLVBL-VL	136297	14	SP2330-BL-RYC	134992	126	WB4120-BK	135018	125
MPLMXLVGR	134897	11	SP2330-GR	134993	125	WB4120-BL-RYC	135019	126
MPLMXLVGR-VL	136303	14	SP2330-SL-BE	134994	125	WB4120-GR	135020	125
MPLMXLVOR	134898	11	SP2330-SL-BK	134995	125	WC101	135613	134
MPLMXLVOR-VL	136309	14	SP2330-SL-BL	134996	126	WC146	135612	133
MPLMXS-BL	134899	10	SP2330-SL-GR	134997	125	WC150	135611	133
MPLMXSGR	134900	10	ST1000	134998	32	WC620	135610	134
MPLMXSOR	134901	10	ST1200	134999	32	WC909	135025	127
MPLMXSV-BL	134902	11	ST24VVB	131609	19	WF1000-1ES	135026	47
MPLMXSVGR	134904	11	SU122704	122705	57	WF9001	135027	48
MPLMXSVOR	134905	11	SW111384	111384	42	WF9002	135028	48
MP-ME3000	134906	9	SW111390	111391	41	WI17-048	135327	46
MP-ME3001	134907	9	SW116866	116867	42	WI17-100	135031	46
MP-ME3002	134908	9	SW117052	510818	42	WI940-01	135032	46
MP-ME3010	134909	9	SW117056	510822	42	WI940-02	135324	46
MP-ME3011	134911	9	SW119908	119909	78	WINGERL	135034	13
MP-ME3012	131604	9	SW119914	512363	78	WINGERL-GR	135035	13
PDQ-BRG18P/54M	134928	79	SW119938	512389	78	WINGERL-OR	135036	13
PDQ-CB108	134929	79	SW120771	120811	96	WINGERLWB	135037	13
PDQ-MP5000CT	136144	79	SW120772	120812	96	WINGERLWB-GR	135038	13
PL2025	134930	133	SW120774	120806	43	WINGERLWB-OR	135040	13
PUP02250	135140	117	SW120774	120806	95	WINGERM	135043	13
PUP02400	135139	117	SW120778	120820	96	WINGERM-GR	135044	13
PUP03450	135138	117	SW120779	120821	43	WINGERM-OR	135045	13
PUP03600	135137	117	SW120779	120821	95	WINGERMWB	131613	13
PUP03900	135136	117	SW120780	120822	43	WINGERMWB-GR	135046	13
PUP04105	135084	117	SW120780	120822	95	WINGERMWB-OR	135048	13
PUP06000	134937	117	SW120781	120809	95	WINGERS	135050	13
PURO0303	139806	116	SW120782	120810	95	WINGER-SGR	135051	13
PURO0305	134939	116	SW120783	120813	95	WINGER-SOR	135052	13
PUR01510	139805	116	SW120784	120814	95	WINGER-SW	135053	13
PUR01530	134941	116	SW120786	120816	96	WINGER-SW-GR	135054	13
PUR01555	134942	116	SW120787	120818	95	WINGER-SW-OR	135056	13
PUR01560	134943	116	SW120788	120788	94	WS09100	135058	115
PUS12030	134944	114	SW120942	120943	43	YM200	135059	20
PUS14035	134945	114	SW120942	120943	94	YMDY10R	135060	20
PUS18045	134948	114	SW120944	120945	43	YMHY10B	135061	21
PUT00600	134947	113	SW120944	120945	94	YMHY10SYNB	135062	20
PUT01300	139792	113	SW121645	513686	41	YMHY12B	135063	21
PUT01350	139793	113	SW121646	513687	41	YMHY12SYNB	135064	20





## **FHP Toronto Warranty**

We are committed to meeting our customers' need and expectations. As a global manufacturer and supplier, we provide expert support to make our customers successful. We deliver superior value through our commitment to quality, service and reliability.

If you find that the product you have received from FHP is not meeting your expectations, we will arrange for it to be replaced, refunded, repaired or recommend an alternative solution.

This warranty does not cover product negligence, alteration, wear and tear, nondurable products or components, improper operation or misuse, and is limited to product that has been purchased within the last twelve months. Discontinued products are not covered under this warranty.





### **Vileda Professional – Marino – part of the Freudenberg Group**

Vileda Professional – Marino provide innovative cleaning solutions and systems for professional users in various application areas, such as General Building, Healthcare and HoReCa. With sales offices in major markets, and a wide network of representatives, we are located around the world.

Vileda Professional – Marino belong to the Freudenberg Group – a diversified family run global company, headquartered in Germany.



Helping you make a difference

#### **Freudenberg Household Products Inc.**

59 Talman Court, Concord, ON, L4K 4L5 Canada

Tel: (905) 669-9949, Fax: (905) 669-5750, Toll Free: 1-800-265-6267

[www.vileda.com](http://www.vileda.com)

A Company of the  
Freudenberg Group 