

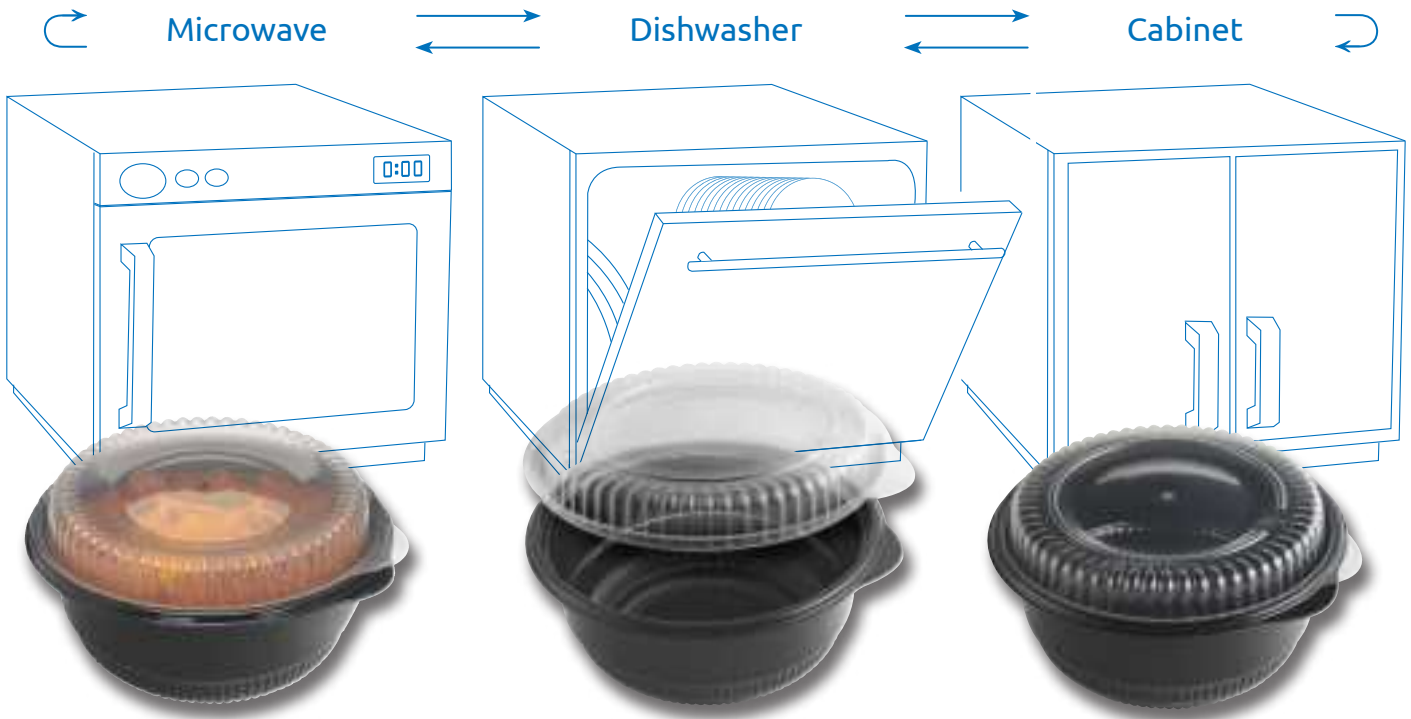



DID YOU RE-USE AN ANCHOR TAKE-OUT CONTAINER TODAY?



Reuse Benefits

Multiple-Use!

Unlike single-use foam and paper containers, an Anchor polypropylene  product is designed to be reused again and again by the consumer. Made from the same material as reusable food storage containers purchased in stores.

Saves Energy!

An Anchor polypropylene  container is specifically designed for microwave re-heating instead of stove or oven heating which requires longer heating times and more energy.

Recycle!

After multiple uses over several months, recycle the polypropylene container when it begins to show wear and tear.

Check your community for recycling information (www.earth911.org).



reusecontainers.com

Sustainable Innovative Packaging

Anchor Packaging offers our customers environmentally neutral products produced in a sustainable manufacturing environment.

Anchor recycles almost 100% of its raw materials and continues to minimize our product designs to reduce waste and shipping fuel costs.





Original Source: Environmental Protection Agency Solid Waste Management Hierarchy

Anchor products offer one or more of these Waste Management Strategy 4R's.

Reduce: Our product development team has greatly reduced the weight and use of petroleum based resins in our products through design, process and material engineering without sacrificing performance. Some of our products have seen reductions in resin of up to 40%! And others use a minimum of 10% post-consumer RPET.



Reuse: Anchor Packaging was the first to introduce the “green” concept of **REUSE**, then recycle polypropylene takeout packaging. The EPA recommends **REUSE** over many other waste management strategies.

Recycle: Anchor’s rigid plastic products are made of  PETE/RPET and  polypropylene. **PETE is the most recycled** food packaging material nationwide. Polypropylene is also eligible for recycling in many communities along with aluminum foil. Check your community for recycling information (www.earth911.org).



Recover (stored energy): Anchor polypropylene products, when safely incinerated in a waste-to-energy facility, produce the **highest per ton BTU energy value of any waste material:** 38 million BTUs per ton. This is twice the energy value of coal, the primary source of electric power generation in the U.S.

Polypropylene = **HIGHEST ENERGY VALUE!**

Operations



St. Louis, Missouri



Paragould, Arkansas



Marmaduke, Arkansas



Paragould, Arkansas



Jonesboro, Arkansas



RockCastle, Kentucky



San Juan, Argentina

Customer Service



Locations:

- ★ World Headquarters
- Rigid Production
- Rigid Production/Warehouse
- Film Production
- Anchor Distribution Center
- Rigid Production/Warehouse

- St. Louis, Missouri USA
- Paragould, Arkansas USA
- RockCastle, Kentucky USA
- Marmaduke, Arkansas USA
- Paragould, Arkansas USA
- Jonesboro, Arkansas USA

International Locations:

- International Division Offices London, England
- South American Division Office Buenos Aires, Argentina
- South American Production San Juan, Argentina

Certifications



Custom Packaging Innovation

Giving You “What’s Next”

For over 50 years, Anchor Packaging has supplied the industry with innovative solutions for consumer package solutions. We continue to expand our knowledge, designs and operational base to create and deliver the answers to tomorrow’s packaging challenges.

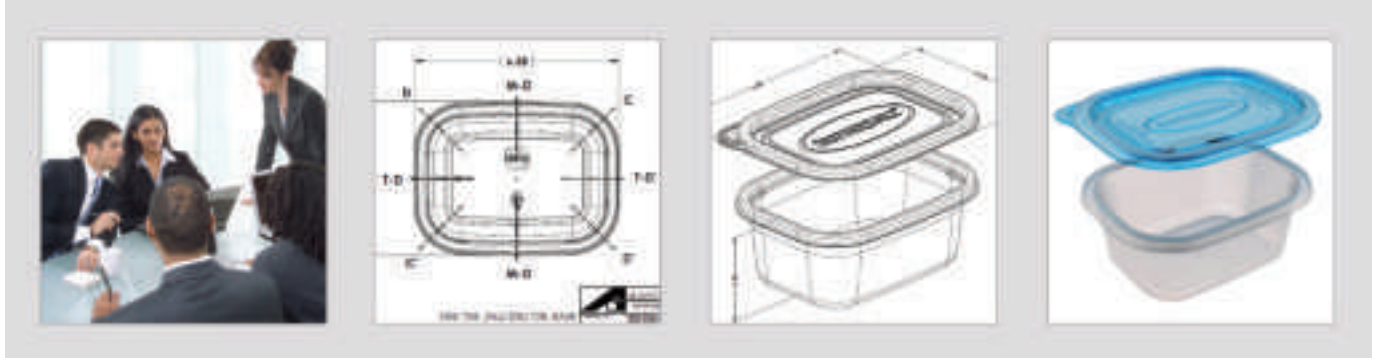

Anchor devotes the resources to bring a stream of new and improved, value-added products and services to market. If your business can benefit from unique packaging that delivers the features and benefits required for your specific product, then Anchor should be your preferred packaging partner. With our optimized 7-step product development process, we can get your product to market in record time. Our turnkey solutions include full product design services, modeling, rapid prototyping, and in-house tool design, to take you from concept to production quickly and economically.

- Ideation through 3-D concept computerized renderings
- Rapid prototyping: 3-D Printed "real feel" samples, SLA models and unit cavity sampling
- Production prototyping

Our Custom Development Process utilizes “smart models”, virtual reality information sharing and the ability to interact directly with one of our highly trained Product Engineers. Some unique technologies that Anchor can deliver include:

- Cost effective solutions with optimized performance
- Internal anti-fog (if applicable)
- Crystal clarity not normally found in polypropylene formulations
- Unique material blends and post-consumer content
- Functionally strong and stylish packaging
- Proprietary tool designs
- Technology to produce uniform sealing surfaces for high-speed applications



Giving You Results

Packaging that lets you stand out from your competition. Anchor Packaging will meet your needs with package performance that leads to better brand awareness and increased consumer appeal.

Hot “Ready to Eat” and Cold “Ready to Reheat” Upscale Takeout Prepared Food Containers for Heat Lamps, Warming Units, Microwaves

MicroRaves® Two-Piece Black Bases and Clear Anti-fog Lids

Round

• Incredi-Bowl® Packages	2-3
• Valu-Bowl	3
• MicroRounds® Packages	3
• M950 Combo	4

Oval

• M900 Series	4
• M1100 Series Platters	9
• The Roaster™ Series	5

Polygon

• M950 Combo	4
--------------------	---

Rectangle

• M400 Series	6-7
• M600 Series	6
• M700 Series	8
• MW800 Series	9
• Mega-Meal™ Packages	10
• Rib Containers	10
• Hot Dog Container (Clear Hinged)	10

Culinary Series One-Piece Hinged and Two-Piece Black Bases with Clear Anti-Fog Lids

Rectangle

• Culinary Classics® Packages (6" x 9")	12
• Culinary Classics® Packages (9 ½" x 10 ½")	12
• Culinary Basics® Package (9 ½" x 10 ½")	13
• Crisp Food Containers (6" x 9", 9 ½" x 10 ½")	13

Square

• Culinary Classics® Packages (9" x 9")	12
• Culinary Basics® Package (9" x 9")	13
• Culinary Squares™ Two-Piece Packages (8.5" x 8.5")	13

MicroLite® Round Clear Deli Cups and Lids

Hot “Ready to Eat” and Cold “Ready to Cook or Reheat” Upscale Takeout Prepared Food Containers for Heat Lamps, Warming Units, Ovens

AnchorFoil™ Aluminum Pans, Pop-up Sheets, and Rolls

Index

• Foodservice Film and Foil Quick Reference Guide	26
• UPC/GTIN Code by Product	38-42

Cold and Non-Refrigerated "Ready to Eat" Upscale Takeout Prepared Food Containers for Refrigerated Case, Freezer, Baked Goods, Produce

CrystalClear™ Two-Piece Black Bases, Clear Bases, and Clear Lids

Round Crystal Classics® Bowls

• 6" CP600 Series	18
• 7" CP700 Series	18
• 8.5" CP8500 Series	18

Square Crystal Classics® Bowls

• 6" CPS600 Series	19
• 7" CPS700 Series	19
• 8" CPS800 Series	19

Rectangle and Square Deli View™ Containers	20
--	----

CrystalClear™ One-Piece Hinged Black or Clear Bases with Clear Lids

• Round Gourmet Classics™ Packages	17
• Rectangle and Square Deli View™ Containers	20
• Polygon Deli View™ Container	21
• Wedge-Sandwich	21

BonFaire® Hinged & Two-Piece Black Meal Trays, Clear Lids, Accessories	23
--	----

Premium and Valu-Grade Cling Film, Shrink Wrap and Stretch Film

Foodservice Cling Film Wrap

• Purity Wrap™ Premium-Grade Cling Wrap in Cutterbox	28
• Canadian Purity Wrap	28
• Safety Cutters – Purity Wrap™	28
• Anchor Wrap™ Premium-Grade Cling Wrap in Cutterbox	29
• Refill Rolls-Anchor Wrap™	29
• Crystal Wrap™ Heavy-Duty Cling Wrap in Cutterbox	29
• Crystal Wrap™ Plus with Dri-Gard™ Cutterbox	29
• Value Wrap™ Value-Grade Cling Wrap in Cutterbox	30
• The Miler® One-Mile of Cling Wrap Rolls	30
• Stainless Steel Speedwrap Dispensers for Miler® Film	30
• Cheese Guard Cling Wrap	30

Perforated Film

• E15 Cling Wrap in Dispenser Box	32
• E15 Cling Wrap Rolls	32
• E9 Shrink Film Rolls	33
• Pizza Shrink Film Rolls	34
• Dispensers for Perforated Films	34

Ultra Wrap™ Meat and Produce Stretch Film	36-37
---	-------

• Pro-Freeze	36
• Meat & Poultry	36

New Products from Anchor Packaging



13515 Barrett Parkway Drive
St. Louis, Missouri 63021
800.467.3900 • 314.822.7800 • Fax: 314.822.7078
anchorpac.com





MICRORAVES[®]



Performance features include:
microwave, heat-lamp, fresh case, cold case
(except as indicated)













	Product Number	SKU Number	Description	Capacity (oz./ml)	Dimensions	Case Wt. (lb/kg)	Case Cube (ft ³ /m ³)	Case Pack	TI/ HI
	M4805B	4604802	Black polypropylene microwavable bowl	5 oz. 148 ml	4.75" x 1.19" 12.1cm x 3cm	9.59 lbs. 4.4 kg	1.93 ft ³ .05 m ³	500	8/7
	M4808B	4604804	Black polypropylene microwavable bowl	8 oz. 237 ml	4.75" x 1.75" 12.1cm x 4.4cm	10.28 lbs. 4.7 kg	1.96 ft ³ .06 m ³	500	8/7
	M4810B	4604810	Black polypropylene microwavable bowl	10 oz. 296 ml	4.75" x 2.13" 12.1cm x 5.4cm	11.85 lbs. 5.4 kg	2.03 ft ³ .06 m ³	500	8/6
	LH4800D	4334810	Clear polypropylene microwavable vented lid for M4800 bowls	-	4.5" x .39" 11.4cm x .99cm	7.66 lbs. 3.5 kg	1.39 ft ³ .04 m ³	500	8/8

Incredi-Bowl®

5.75" Round M5800 Series with Anti-Fog Lids



	Product Number	SKU Number	Description	Capacity (oz./ml)	Dimensions	Case Wt. (lb/kg)	Case Cube (ft ³ /m ³)	Case Pack	TI/ HI
	M5816B	4605816	Black polypropylene microwavable bowl	12 oz.	5.75" x 2.02"	8.54 lbs./3.9 kg	1.55 ft ³ /.05 m ³	250	8/7
		4605817		355 ml	14.6cm x 5.1cm	16.66 lbs. 7.6 kg	2.74 ft ³ /.08 m ³	500	4/7
	M5820B	4605821	Black polypropylene microwavable bowl	16 oz.	5.75" x 2.43"	9.75 lbs./4.4 kg	1.58 ft ³ /.05 m ³	250	8/7
		4605820		473 ml	14.6cm x 6.2cm	19.42 lbs. 8.8 kg	2.95 ft ³ /.09 m ³	500	4/7
	M5824B	4605824	Black polypropylene microwavable bowl	24 oz. 710 ml	5.75" x 3.02" 14.6cm x 7.7cm	22.48 lbs./10.2 kg	2.79 ft ³ /.08 m ³	500	6/5
	LH5800D	4335802	Clear polypropylene microwavable vented lid for M5800 bowls	-	5.5" x 0.70"	5.52 lbs./2.5 kg	1.24 ft ³ /.04 m ³	250	10/7
		4335800		14cm x 1.8cm	10.19 lbs. 4.6 kg	1.96 ft ³ /.05 m ³	500	6/8	
	LH5800S	4335820	Clear polypropylene microwavable vented lid for M5800 bowls	-	5.5" x 0.47" 14cm x 1.2cm	9.80 lbs./4.4 kg	1.96 ft ³ /.05 m ³	250	6/8
	CDM5816B	4115816	Black polypropylene microwavable bowl and clear vented lid combo pack	12 oz. 355 ml	5.75" x 2.63" 14.6 cm x 6.7 cm	14.65 lbs./6.65 kg	2.73 ft ³ /.08 m ³	250/ 250	6/5
	CDM5820B	4115820	Black polypropylene microwavable bowl and clear vented lid combo pack	16 oz. 473 ml	5.75" x 3.00" 14.6 cm x 7.6 cm	15.37 lbs./6.97 kg	2.97 ft ³ /.09 m ³	250/ 250	6/5
	CDM5824B	4115824	Black polypropylene microwavable bowl and clear vented lid combo pack	24 oz. 709 ml	5.75" x 3.63" 14.6 cm x 9.2 cm	17.67 lbs./8.02 kg	2.97 ft ³ /.08 m ³	250/ 250	6/5



	Product Number	SKU Number	Description	Capacity (oz./ml)	Dimensions	Case Wt. (lb/kg)	Case Cube (ft ³ /m ³)	Case Pack	TI/HI
	M8524B	4608524	Black polypropylene microwavable bowl	24 oz. 710 ml	8.5" x 1.51" 21.6cm x 3.8cm	9.19 lbs. 4.2 kg	1.83 ft ³ .05 m ³	150	10/5
	M8532B	4608532	Black polypropylene microwavable bowl	32 oz. 946 ml	8.5" x 1.92" 21.6cm x 4.9cm	10.71 lbs. 4.9 kg	1.90 ft ³ .05 m ³	150	10/4
	M8548B	4608548	Black polypropylene microwavable bowl	48 oz. 1420 ml	8.5" x 2.7" 21.6cm x 6.9cm	11.99 lbs. 5.4 kg	2 ft ³ .06 m ³	150	10/4
	LH8500D	4338505	Clear polypropylene vented lid for M8500 bowls	-	8.5" x .63" 21.6cm x 1.6cm	7.88 lbs. 3.6 kg	1.99 ft ³ .06 m ³	150	10/4
	CDM8524B ^o	4118500	Black polypropylene bowl and clear polypropylene vented lid combo pack	24 oz. 710 ml	See component parts	22.36 lbs. 10.14 kg	4.29 ft ³ .13 m ³	200/ 200	4/6
	CDM8532B	4118533	Black polypropylene bowl and clear polypropylene vented lid combo pack	32 oz. 946 ml	See component parts	24.67 lbs. 11.19 kg	5.32 ft ³ .16 m ³	200/ 200	4/5

^oNon-stocking. Call for lead times.

8.5" Round Valu-Bowl



	Product Number	SKU Number	Description	Capacity (oz./ml)	Dimensions	Case Wt. (lb/kg)	Case Cube (ft ³ /m ³)	Case Pack	TI/HI
	M8527B	4608528	Black polypropylene microwavable bowl	28 oz. 828 ml	8.5" x 1.38" 21.6cm x 3.5cm	15.58 lbs 7.1 kg	3.50 ft ³ .11m ³	288	8/3
	LH8527	4338528	Clear polypropylene microwavable vented lid for M8527 bowl	-	8.5" x .79" 21.6cm x 2.0cm	13.41 lbs 6.1 kg	3.14 ft ³ .10m ³	288	8/3
	CDM8527B	4118528	Black polypropylene bowl and clear polypropylene vented lid combo pack	28 oz. 828 ml	See component parts	21.10 lbs 9.6 kg	5.03 ft ³ .15m ³	200/ 200	4/5

7" Round MicroRounds®

M200 Series with Anti-Fog Lids



	Product Number	SKU Number	Description	Capacity (oz./ml)	Dimensions	Case Wt. (lb/kg)	Case Cube (ft ³ /m ³)	Case Pack	TI/HI
	M212B ^o	4492212	Black polypropylene microwavable bowl	12 oz. 355 ml	7" x 6.33" x 1.55" 17.8 cm x 16.1 cm x 3.9 cm	8.97 lbs. 4.1 kg	1.99 ft ³ .06 m ³	250	9/5
	M216B	4492216	Black polypropylene microwavable bowl	16 oz. 473 ml	7" x 6.33" x 1.96" 17.8 cm x 16.1 cm x 5 cm	10.86 lbs. 4.9 kg	2.11 ft ³ .06 m ³	250	9/5
	M224B ^o	4492224	Black polypropylene microwavable bowl	24 oz. 710 ml	7" x 6.33" x 2.85" 17.8 cm x 16.1 cm x 7.2 cm	13.34 lbs. 6.1 kg	2.23 ft ³ .06 m ³	250	9/4
	LH2F	4492200	Clear polypropylene microwavable vented dome lid	-	6.64" x 5.88" x .53" 16.9 cm x 14.9 cm x 1.3 cm	6.90 lbs. 3.1 kg	1.82 ft ³ .05 m ³	250	9/6

^oNon-stocking. Call for lead times.

8"- 9" Oval M900 Series

with Anti-Fog Lids



	Product Number	SKU Number	Description	Capacity (oz./ml)	Dimensions	Case Wt. (lb/kg)	Case Cube (ft ³ /m ³)	Case Pack	TI/ HI
	M912B	4590912	Black polypropylene microwavable platter	12 oz. 355 ml	8" x 5.73" x 1.35" 20.3 cm x 14.6 cm x 3.4 cm	8.09 lbs. 3.7 kg	1.50 ft ³ .04 m ³	250	8/7
	M916B	4590916	Black polypropylene microwavable platter	16 oz. 473 ml	8" x 5.73" x 1.48" 20.3 cm x 14.6 cm x 3.8 cm	8.98 lbs. 4.1 kg	1.74 ft ³ .05 m ³	250	8/6
	LC9D*	4409000	Clear PETE dome lid for M912B and M916B	-	8" x 5.65" x .93" 20.3 cm x 14.4 cm x 2.4 cm	7.58 lbs. 3.4 kg	1.28 ft ³ .04 m ³	250	10/7
	LH9D	4339000	Clear polypropylene microwavable vented dome lid for M912B and M916B	-	8" x 5.73" x 1.41" 20.3 cm x 14.6 cm x 3.6 cm	8.44 lbs. 3.8 kg	1.58 ft ³ .04 m ³	250	9/7
	MW924B	4590244	Black polypropylene microwavable platter	24 oz. 710 ml	9" x 6.25" x 1.63" 22.9 cm x 15.9 cm x 4.1 cm	12.02 lbs. 5.5 kg	2.07 ft ³ .06 m ³	250	8/6
	L9000*	4309000	Clear RPET flat lid for MW924B	-	9" x 6.25" x .25" 22.9 cm x 15.9 cm x .6 cm	11.56 lbs. 5.2 kg	2.07 ft ³ .06 m ³	250	8/6
	L9024*	4309006	Clear RPET dome lid for MW924B platter	-	9" x 6.25" x 1" 22.9 cm x 15.9 cm x 2.5 cm	11.64 lbs. 5.3 kg	1.57 ft ³ .04 m ³	250	7/7
	CDM912B*	4119120	M912B container and LC9D lid Combo Pack	12 oz. 355 ml	see components	7.77 lbs. 3.5 kg	1.50 ft ³ .04 m ³	125/ 125	8/7
	CDM916B*	4119160	M916B container and LC9D lid Combo Pack	16 oz. 473 ml	see components	8.32 lbs. 3.8 kg	1.74 ft ³ .05 m ³	125/ 125	8/6
	CDMW924B*	4119243	MW924B container and L9024 lid Combo Pack	24 oz. 710 ml	see components	11.23 lbs. 5.1 kg	1.94 ft ³ .05 m ³	125/ 125	6/7

*Lid not microwavable or heat resistant.

9.5" Round M950 Combo

with Anti-Fog Lids



	Product Number	SKU Number	Description	Capacity (oz./ml)	Dimensions	Case Wt. (lb/kg)	Case Cube (ft ³ /m ³)	Case Pack	TI/ HI
	CDM950D	4119500	Black polypropylene microwavable polygon base w/clear vented PP lid combo pack	48 oz. 1419 ml	9.5" x 3" 24.1cm x 7.6cm	14.77 lbs. 6.70 kg	3.21 ft ³ 0.10 m ³	100/ 100	4/6











	Product Number	SKU Number	Description	Dimensions	Case Wt. (lb/kg)	Case Cube (ft ³ /m ³)	Case Pack	TI/ HI
	4110300	4110300	Extra Large Roaster Grande™ black polypropylene microwavable base, clear high dome vented lid combo pack	10.30" x 8.94" x 4.77" 26.2cm x 22.7cm x 12.1 cm	17.54 lb 7.9 kg	3.89 ft ³ .11m ³	100/ 100	4/5
	WDM1180	4110415	Large Premium Roaster black polypropylene microwavable base, clear high dome vented lid combo pack	10.7" x 7.9" x 4.5" 27.2cm x 20.1cm x 11.4 cm	26.25 lb 11.9 kg	4.53 ft ³ .14 m ³	150/ 150	6/4
	WDM1180	4110410	Large Premium Roaster white polypropylene microwavable base, clear high dome vented lid combo pack	10.7" x 7.9" x 4.5" 27.2cm x 20.1cm x 11.4 cm	26.25 lb 11.9 kg	4.53 ft ³ .14 m ³	150/ 150	6/4
	4110001	4110001	Large Roaster black polypropylene microwavable base, clear high dome vented lid combo pack	9.93" x 7.71" x 4.68" 25.2 cm x 19.6 cm x 11.9 cm	15.01 lbs. 6.8 kg	3.20 ft ³ .10 m ³	100/ 100	6/5
	4110005 ^o	4110005			17.70 lbs. 8.0 kg	3.83 ft ³ .11 m ³	120/ 120	6/5
	4110004 ^o	4110004	Large Roaster black polypropylene microwavable base, clear high dome vented lid with sleeve combo pack	9.93" x 7.71" x 4.68" 25.2 cm x 19.6 cm x 11.9 cm	20.52 lbs. 9.3 kg	3.33 ft ³ .10 m ³	100/ 100/ 100/	6/5
	4110600	4110600	Nature's Best® Large Roaster Black polypropylene microwavable base, clear high dome vented lid combo pack	9.38" x 7.45" x 4.5" 23.8cm x 18.9cm x 11.4cm	20.18 lbs 9.2 kg	3.97 ft ³ 0.11 m ³	170/ 170	6/4
	4110650	4110650	Nature's Best® Large Roaster Black polypropylene microwavable base, clear low dome vented lid combo pack	9.38" x 7.45" x 3.6" 23.8cm x 18.9cm x 9.1cm	18.65 lbs 8.4 kg	3.76 ft ³ 0.11 m ³	170/ 170	6/4
	4110100	4110100	Small Roaster black polypropylene microwavable base, clear high dome vented lid combo pack	9.62" x 7.38" x 4" 24.4 cm x 18.7 cm x 10.2 cm	15.3 lbs. 6.94 kg	3.69 ft ³ .11 m ³	100/ 100	6/4
	CDM1185	4111185	Low-dome Roaster black polypropylene microwavable base, clear vented lid combo pack	10.7" x 7.9" x 3.6" 27.2 cm x 20.1 cm x 9.1 cm	12.89 lbs. 5.9 kg	2.10 ft ³ .06 m ³	100/ 100	9/4

^oNon-stocking. Call for lead times.

M400 Series

Small Rectangle with Anti-Fog Lids



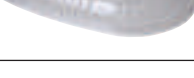

	Product Number	SKU Number	Description	Capacity (oz./ml)	Dimensions	Case Wt. (lb/kg)	Case Cube (ft ³ /m ³)	Case Pack	TI/ HI
	M408B	8oz available in combo pack only							
	M412B	4540412	Black polypropylene single-serve microwavable rectangular container	12 oz. 355 ml	6" x 5" x 1.83" 15.2 cm x 12.7 cm x 4.6 cm	15.77 lbs. 7.2 kg	3.55 ft ³ .10 m ³	500	6/4
	LC4SD*	4304004	Clear RPET dome lid for M412B	-	6" x 5" x .90" 15.2 cm x 12.7 cm x 2.3 cm	10.96 lbs. 5.0 kg	2.89 ft ³ .08 m ³	500	8/4
	M416B	4540416	Black polypropylene single-serve microwavable rectangular container	16 oz. 473 ml	8.85" x 6.41" x 1.17" 22.5 cm x 16.3 cm x 3 cm	10.70 lbs. 4.9 kg	2.25 ft ³ .06 m ³	250	7/6
	M424B	4540424	Black polypropylene multi-serving microwavable rectangular container	24 oz. 710 ml	8.85" x 6.41" x 1.51" 22.5 cm x 16.3 cm x 3.8 cm	11.57 lbs. 5.2 kg	2.25 ft ³ .06 m ³	250	7/5
	M432B	4540433	Black polypropylene multi-serving microwavable rectangular container	32 oz. 946 ml	8.85" x 6.41" x 1.94" 22.5 cm x 16.3 cm x 4.9 cm	14.49 lbs. 6.6 kg	2.47 ft ³ .08 m ³	250	10/4
	L4000*	4304006	Clear RPET lid for M416B, M424B, M432B	-	8.75" x 6.31" x .25" 22.2 cm x 16 cm x .6 cm	11.97 lbs. 5.4 kg	1.60 ft ³ .05 m ³	250	8/5
	LC4LD*	4304000	Clear RPET dome lid for M416B, M424B, M432B	-	8.85" x 6.41" x 1.00" 22.5 cm x 16.3 cm x 2.5 cm	10.22 lbs. 4.6 kg	1.96 ft ³ .06 m ³	250	7/7
	LH4LD	4334000	Clear polypropylene microwavable vented dome lid for M416B, M424B, M432B	-	8.85" x 6.41" x 1.00" 22.5 cm x 16.3 cm x 2.5 cm	10.70 lbs. 4.9 kg	1.80 ft ³ .05 m ³	250	7/7

*Lid not microwavable or heat resistant.

M600 Series

Small Rectangle with Anti-Fog Lids

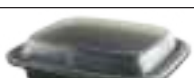

	Product Number	SKU Number	Description	Capacity (oz./ml)	Dimensions	Case Wt. (lb/kg)	Case Cube (ft ³ /m ³)	Case Pack	TI/ HI
	M616B	4541650	Black polypropylene microwavable base	16 oz. 473 ml	6.62" x 5.75" x 1.76" 16.8cm x 14.6cm x 4.5cm	28.91 lbs. 13.1 kg	4.04 ft ³ .11 m ³	756	6/4
	LH600	4331650	Clear polypropylene anti-fog microwavable vented lid	-	6.68" x 5.81" x .92" 16.9cm x 14.8cm x 2.3cm	21.48 lbs. 9.7 kg	4.40 ft ³ .12 m ³	756	6/4
	CDM616B	4111650	Black polypropylene microwavable base with clear vented lid combo	16 oz. 473 ml	6.62" x 5.75" x 2.40" 16.9cm x 14.6cm x 6.1cm	13.80 lbs. 6.3 kg	2.23 ft ³ .06 m ³	200/ 200	6/8









	Product Number	SKU Number	Description	Capacity (oz. /ml)	Dimensions	Case Wt. (lb/kg)	Case Cube (ft ³ /m ³)	Case Pack	TI/HI
	CDM408B*	4114080	M408B container and LC4SD lid Combo Pack	8 oz. 234 ml	6" x 5" x 2.05" 15.2 cm x 12.7 cm x 5.2 cm	12.78 lbs. 5.8 kg	3.49 ft ³ .10 m ³	250/ 250	6/4
	CDM412B*	4114120	M412B container and LC4SD lid Combo Pack	12 oz. 355 ml	see components	14.61 lbs. 6.6 kg	3.55 ft ³ .10 m ³	250/ 250	6/4
	CDM416B*	4114160	M416B container and LC4LD lid Combo Pack	16 oz. 473 ml	see components	10.25 lbs. 4.7 kg	2.25 ft ³ .06 m ³	125/ 125	7/6
	CDM416BLH	4114168	M416B container and LH4LD lid Combo Pack	16 oz. 473 ml	see components	10.69 lbs. 4.9 kg	2.25 ft ³ .06 m ³	125/ 125	7/6
	CDM424B*	4114245	M424B container and LC4LD lid Combo Pack	24 oz. 710 ml	see components	10.62 lbs. 4.8 kg	2.25 ft ³ .06 m ³	125/ 125	7/5
	CDM424BLH	4114246	M424B container and LH4LD lid Combo Pack	24 oz. 710 ml	see components	11.60 lbs. 5.3 kg	2.25 ft ³ .06 m ³	125/ 125	7/5
	CDM432B*	4114320	M432B container and LC4LD lid Combo Pack	32 oz. 946 ml	see components	11.96 lbs. 5.4 kg	2.50 ft ³ .07 m ³	125/ 125	7/5
	CDM432BLH	4114329	M432B container and LH4LD lid Combo Pack	32 oz. 946 ml	see components	12.41 lbs. 5.6 kg	2.50 ft ³ .07 m ³	125/ 125	7/5

*Lid not microwavable or heat resistant.

M700 Series

Medium Rectangle with Anti-Fog Lids

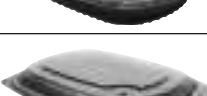

	Product Number	SKU Number	Description	Capacity (oz./ml)	Dimensions	Case Wt. (lb/kg)	Case Cube (ft ³ /m ³)	Case Pack	TI/ HI
	M710B	4540700	Black polypropylene microwavable platter	32 oz. 946 ml	10.25" x 7.25" x 1.45" 26cm x 18.4cm x 3.7cm	15.19 lbs. 6.9 kg	3.03 ft ³ .09 m ³	250	5/5
	M710D	4540710	Black polypropylene deep microwavable platter	48 oz. 1478 ml	10.25" x 7.25" x 2.22" 26cm x 18.4cm x 5.7cm	18.41 lbs. 8.4 kg	3.17 ft ³ .10 m ³	250	5/5
	M712B	4540712	Black polypropylene 2-compartment microwavable platter	21/10 oz. 620/295 ml	10.25" x 7.25" x 1.5" 26cm x 18.4cm x 3.8cm	15.13 lbs. 6.9 kg	3.03 ft ³ .09 m ³	250	5/5
	M713B	4540713	Black polypropylene 3-compartment microwavable platter	15/5/5 oz. 433/147/ 147 ml	10.25" x 7.25" x 1.34" 26cm x 18.4cm x 3.4cm	15.74 lbs. 7.1 kg	3.17 ft ³ .10 m ³	250	5/5
	LC710D*	4300710	Clear RPET dome lid	-	10.25" x 7.25" x .93" 26cm x 18.4cm x 2.4cm	14.31 lbs. 6.5 kg	2.45 ft ³ .07 m ³	250	5/7
	LH710D	4330700	Clear polypropylene microwavable dome vented lid	-	10.25" x 7.25" x .94" 26cm x 18.4cm x 2.4cm	13.97 lbs. 6.3 kg	2.48 ft ³ .07 m ³	250	5/6
	LH712D	4330712	Clear polypropylene 2-compartment dome microwavable vented lid	-	10.25" x 7.25" x 1.08" 26cm x 18.4cm x 2.7cm	14.17 lbs. 6.4 kg	2.27 ft ³ .06 m ³	250	5/6
	LH713D	4330713	Clear polypropylene 3-compartment dome microwavable vented lid	-	10.25" x 7.25" x 1.08" 26cm x 18.4cm x 2.7cm	14.09 lbs. 6.4 kg	2.32 ft ³ .07 m ³	250	6/6
	CDM710/ LC710D	4117110*	Black polypropylene platter and clear RPET lid combo	32 oz. 946 ml	See component parts	15 lbs. 6.8 kg	3.26 ft ³ .09 m ³	125/ 125	5/5
	CDM710/ LH710D	4117100	Black polypropylene platter and clear polypropylene lid combo	32 oz. 946 ml	See component parts	14.50 lbs. 6.6 kg	3.03 ft ³ .09 m ³	125/ 125	5/5
	CDM712/ LH710D	4110712	Black polypropylene platter and clear polypropylene lid combo	21/10 oz. 620/295 ml	See component parts	14.66 lbs. 6.6 kg	3.03 ft ³ .09 m ³	125/ 125	5/5
	CDM713/ LH713D	4117013	Black polypropylene platter and clear polypropylene lid combo	15/5/5 oz. 433/147/147 ml	See component parts	14.90 lbs. 6.8 kg	3.17 ft ³ .09 m ³	125/ 125	5/5

*Lid not microwavable or heat resistant.

MW800 Series

Large Rectangle with Anti-Fog Lids



	Product Number	SKU Number	Description	Capacity (oz./ml)	Dimensions	Case Wt. (lb/kg)	Case Cube (ft ³ /m ³)	Case Pack	TI/HI
	MW810B	4608101	Black polypropylene 1-compartment, microwavable platter	29.5 oz. 872 ml	9.5" x 5.88" x 1.38" 24.1 cm x 14.9 cm x 3.5 cm	11.96 lbs. 5.4 kg	1.95 ft ³ .06 m ³	250	7/7
	MW812B	4608121	Black polypropylene 2-compartment, microwavable platter	19/9.5 oz. 562/281 ml	9.5" x 5.88" x 1.38" 24.1 cm x 14.9 cm x 3.5 cm	11.96 lbs. 5.4 kg	1.95 ft ³ .06 m ³	250	7/6
	MW813B	4608131	Black polypropylene 3-compartment, microwavable platter	18/4/4 oz. 532/ 118/118 ml	9.5" x 5.88" x 1.38" 24.1 cm x 14.9 cm x 3.5 cm	11.96 lbs. 5.4 kg	1.95 ft ³ .06 m ³	250	7/6
	L8000*	4380000	Clear RPET flat lid	-	9.5" x 5.88" x .25" 24.1 cm x 14.9 cm x .6 cm	11.53 lbs. 5.2 kg	1.53 ft ³ .04 m ³	250	12/4
	L8005*	4380005	Clear RPET dome lid	-	9.5" x 5.88" x 1.5" 24.1 cm x 14.9 cm x 3.8 cm	11.07 lbs. 5.0 kg	1.95 ft ³ .06 m ³	250	7/7
	L810PP	4338100	Clear polypropylene microwavable dome lid	-	9.5" x 5.88" x .63" 24.1 cm x 14.9 cm x 1.6 cm	12.74 lbs. 5.8 kg	1.95 ft ³ .06 m ³	250	7/6
	L812PP°	4338120	Clear polypropylene microwavable 2-compartment dome lid	-	9.5" x 5.88" x .63" 24.1 cm x 14.9 cm x 1.6 cm	12.65 lbs. 5.7 kg	1.93 ft ³ .05 m ³	250	7/6
	L813PP°	4338130	Clear polypropylene microwavable 3-compartment dome lid	-	9.5" x 5.88" x .63" 24.1 cm x 14.9 cm x 1.6 cm	12.65 lbs. 5.7 kg	1.93 ft ³ .05 m ³	250	7/6

*Lid not microwavable or heat resistant. °Non-stocking. Call for lead times.

11" Oval M1100 Series





Platters with Anti-Fog Lids



	Product Number	SKU Number	Description	Capacity (oz./ml)	Dimensions	Case Wt. (lb/kg)	Case Cube (ft ³ /m ³)	Case Pack	TI/ HI
	M1180°	4591182	Black polypropylene shallow microwavable platter	16 oz. 473 ml	10.7" x 7.9" x .66" 27.2 cm x 20.1 cm x 1.7 cm	15.46 lbs. 7.0 kg	2.71 ft ³ .08 m ³	250	6/5
	M1180D	4591185	Black polypropylene deep microwavable platter	36 oz. 1064 ml	10.7" x 7.9" x 1.67" 27.2 cm x 20.1 cm x 3.8 cm	15.46 lbs. 7.0 kg	2.83 ft ³ .08 m ³	250	4/6
	LH1180	4331180	Clear polypropylene microwavable shallow vented lid for M1180 and M1180D	-	10.7" x 7.9" x .93" 27.2 cm x 20.1 cm x 2.4 cm	14.17 lbs. 6.4 kg	2.52 ft ³ .09 m ³	250	6/5
	LH1180D	4331185	Clear polypropylene microwavable deep vented lid for M1180 or M1180D	-	10.7" x 7.9" x 1.93" 27.2cm x 20.1cm x 4.9cm	16.25 lbs. 7.4 kg	2.79 ft ³ .09 m ³	250	6/5
	M1825B	4591825	Black polypropylene deep microwavable platter lid with cup locator*	25 oz. 739 ml	10.7" x 7.9" x 1.93" 27.2cm x 20.1cm x 4.9cm	16.68 lbs. 7.6 kg	2.62 ft ³ .07 m ³	250	4/7
	LH1835	4331835	Clear polypropylene microwavable deep vented lid with cup locator*	-	10.7" x 7.9" x 1.93" 27.2cm x 20.1cm x 4.9cm	14.73 lbs. 6.7 kg	3.14 ft ³ .09 m ³	250	4/6

°Non-stocking. Call for lead times. *Cup not included.





	Product Number	SKU Number	Description	Capacity (oz./ml)	Dimensions	Case Wt. (lb/kg)	Case Cube (ft ³ /m ³)	Case Pack	TI/ HI
	M1238*	4542038	Shallow half-steam polypropylene microwavable family-pack container	38 oz 1124 ml	12.38" x 10.25" x 1.24" 31.4cm x 18.9cm x 3.2cm	14.36 lb 6.5 kg	2.53 ft ³ .07 m ³	100	9/4
	M1280*	4542080	Medium half-steam polypropylene microwavable family-pack container	80 oz 2365 ml	12.38" x 10.25" x 2.32" 31.4cm x 18.9cm x 5.9cm	16.97 lb 7.7 kg	2.76 ft ³ .08 m ³	100	8/4
	M1200*	4542100	Deep half-steam polypropylene microwavable family-pack container	100 oz 2957 ml	12.38" x 10.25" x 2.56" 31.4cm x 18.9cm x 6.5cm	18.86 lb 8.6 kg	2.74 ft ³ .08 m ³	100	7/4
	LH1200	4332000	Clear polypropylene microwavable Lid fits all half-steam containers	-	12.38" x 10.25" x 1.22" 31.4cm x 18.9cm x 3.1cm	11.20 lb 5.1 kg	2.06 ft ³ .06 m ³	100	6/7

*Not to be used in direct contact with sterno flames.

Rib Containers



	Product Number	SKU Number	Description	Dimensions	Case Wt. (lb/kg)	Case Cube (ft ³ /m ³)	Case Pack	TI/ HI
	M1670*	4402000	Full-slab microwavable polypropylene black base and vented OPS lid combo pack	16.63" x 7" x 2.33" 42.2 cm x 17.8 cm x 5.9 cm	20.92 lbs. 9.5 kg	3.54 ft ³ .10 m ³	100/ 100	5/5
	M1070*	4401900	Half-slab microwavable polypropylene black base and vented OPS lid combo pack	10.88" x 7" x 2.33" 27.6 cm x 17.8 cm x 5.9 cm	12.13 lbs 5.5 kg	2.42 ft ³ .07 m ³	100/ 100	6/6

*Lid microwavable one time.

Hot Dog Container



	Product Number	SKU Number	Description	Dimensions	Case Wt. (lb/kg)	Case Cube (ft ³ /m ³)	Case Pack	TI/ HI
	4489409	4489409	6" microwavable polypropylene hinged hotdog container	7.94" x 3.63" x 1.5" 20.2 cm x 9.2 cm x 3.8 cm	10.97 lbs. 5.0 kg	2.45 ft ³ .07 m ³	250	6/6

Culinary SERIES



Performance features include:
microwave, heat-lamp, fresh case, cold case



Small Hinged

6" x 9" with Anti-Fog Lids for Appetizers & Side Dishes



	Product Number	SKU Number	Description	Capacity (oz./ml)	Dimensions	Case Wt. (lb/kg)	Case Cube (ft ³ /m ³)	Case Pack	TI/ HI
	CC6911B	4656911	Microwavable 1 compartment base/1 compartment vented lid hinged clamshell	34 oz. 1005 ml	6" x 9" x 3" 15.2 cm x 22.9 cm x 7.6 cm	12.97 lbs. 5.9 kg	2.55 ft ³ .072 m ³	100	9/4
	CC6922B	4656922	Microwavable 2 compartment base/2 compartment vented lid hinged clamshell	18.5/11.5 547/340 ml	6" x 9" x 3" 15.2 cm x 22.9 cm x 7.6 cm	13.58 lbs. 6.2 kg	2.55 ft ³ .072 m ³	100	6/4

Medium Tear-Away Hinged

9" x 9" with Anti-Fog Lids for Small Portions & Entrées



	Product Number	SKU Number	Description	Capacity (oz./ml)	Dimensions	Case Wt. (lb/kg)	Case Cube (ft ³ /m ³)	Case Pack	TI/ HI
	CC9911B	4659111	Microwavable 1-compartment base/1-compartment vented lid hinged clamshell	39 oz. 1153 ml	9" x 9" x 3.125" 22.9 cm x 22.9 cm x 7.9 cm	14.75 lbs. 6.7 kg	3.27 ft ³ .093 m ³	100	6/5
	CC9931B	4659131	Microwavable 3-compartment base/1-compartment vented lid hinged clamshell	20/5/5 oz. 592/ 148/148 ml	9" x 9" x 3.125" 22.9 cm x 22.9 cm x 7.9 cm	14.97 lbs. 6.8 kg	3.27 ft ³ .093 m ³	100	6/5
	CC9933B	4659133	Microwavable 3-compartment base/3-compartment vented lid hinged clamshell	20/5/5 oz. 592/ 148/148 ml	9" x 9" x 3.125" 22.9 cm x 22.9 cm x 7.9 cm	14.97 lbs. 6.8 kg	3.27 ft ³ .093 m ³	100	6/5

Large Tear-Away Hinged

9.5" x 10.5" with Anti-Fog Lids for Entrées & Family Meals



	Product Number	SKU Number	Description	Capacity (oz./ml)	Dimensions	Case Wt. (lb/kg)	Case Cube (ft ³ /m ³)	Case Pack	TI/ HI
	CC91011B	4659611	Microwavable 1-compartment base/1-compartment vented lid hinged clamshell	47.5 oz. 1405 ml	9.5" x 10.5" x 3.125" 24.1 cm x 26.7 cm x 7.9 cm	17.09 lbs. 7.8 kg	3.89 ft ³ .11 m ³	100	6/4
	CC91031B	4659631	Microwavable 3-compartment base/1-compartment vented lid hinged clamshell	26/7/7 oz. 769/ 207/207 ml	9.5" x 10.5" x 3.25" 24.1 cm x 26.7 cm x 8.26 cm	18.0 lbs. 8.2 kg.	3.88 ft ³ .11 m ³	100	6/4
	CC91033B	4659633	Microwavable 3-compartment base/3-compartment vented lid hinged clamshell	26/7/7 oz. 769/ 207/207 ml	9.5" x 10.5" x 3.125" 24.1 cm x 26.7 cm x 7.9 cm	18.0 lbs. 8.2 kg.	3.88 ft ³ .11 m ³	100	6/4

Medium & Large Hinged

with Anti-Fog Lids for Entrées & Family Meals



	Product Number	SKU Number	Description	Capacity (oz. /ml)	Dimensions	Case Wt. (lb/kg)	Case Cube (ft ³ /m ³)	Case Pack	TI/ HI
	CB9911B	4669911	Microwavable 1-compartment hinged, vented clamshell	36 oz. 1064 ml	9" x 9" x 2.5" 22.9cm x 22.9cm x 6.4cm	12.69 lbs. 5.8 kg	2.97 ft ³ .091 m ³	100	6/5
	CB91011B	4669111	Microwavable 1-compartment hinged, vented clamshell	46.5 oz. 1375 ml	9.5" x 10.5" x 2.5" 24.1cm x 26.7cm x 6.4cm	15.02 lb. 6.8 kg	3.41 ft ³ .10 m ³	100	7/4

Crisp Food Hinged Containers

with Anti-Fog Lids



	Product Number	SKU Number	Description	Capacity (oz. /ml)	Dimensions	Case Wt. (lb/kg)	Case Cube (ft ³ /m ³)	Case Pack	TI/ HI
	CB910F	4669101	Microwavable, 1-compartment hinged, Convection Cross-Flow [®] vented clamshell	74 oz. 2188 ml	9.5" x 10.5" x 3.5" 24.1cm x 26.7cm x 8.9cm	20.14 lbs. 9.1 kg	4.63 ft ³ .14 m ³	100	6/4
	CB690F	4666901	Microwavable, 1-compartment hinged, Convection Cross-Flow [®] vented clamshell	35 oz. 1035 ml	6.7" x 9.5" x 3.8" 17cm x 24.1cm x 9.7cm	12.93 lbs. 5.9 kg	2.62 ft ³ .08 m ³	100	8/4

Two-Piece Medium Squares

8.5" x 8.5" with Anti-Fog Lids for Entrées & Side Dishes



	Product Number	SKU Number	Description	Capacity (oz. /ml)	Dimensions	Case Wt. (lb/kg)	Case Cube (ft ³ /m ³)	Case Pack	TI/ HI
	CS85321B	4688521	Black polypropylene square 1-compartment, microwavable base	36 oz. 1064 ml	8.46" x 8.46" x 1.55" 21.5 cm x 21.5 cm x 3.9 cm	20.4 lbs. 9.3 kg	2.63 ft ³ .07 m ³	300	9/3
	CS85323B	4688523	Black polypropylene square 3-compartment, microwavable base	21/6/6 oz. 620/177/177 ml	8.46" x 8.46" x 1.78" 21.5 cm x 21.5 cm x 4.5 cm	21.1 lbs. 9.6 kg	2.63 ft ³ .07 m ³	300	9/3
	CS85LH1	4338521	Clear polypropylene square 1-compartment vented anti-fog microwavable lid	-	8.46" x 8.46" x .96" 21.5 cm x 21.5 cm x 2.4 cm	15.9 lbs. 7.2 kg	3.01 ft ³ .09 m ³	300	9/3
	CS85LH3	4338523	Clear polypropylene square 3-compartment vented anti-fog microwavable lid	-	8.46" x 8.46" x .96" 21.5 cm x 21.5 cm x 2.4 cm	17.3 lbs. 7.8 kg	3.01 ft ³ .09 m ³	300	9/3
	CDS8511	4118521	1-comp. black polypropylene base and 1-comp. clear polypropylene anti-fog lid vented microwavable combo pack	36 oz. 1064 ml	8.46" x 8.46" x 2.25" 21.5 cm x 21.5 cm x 5.7 cm	18.1 lbs. 8.2 kg	3.01 ft ³ .09 m ³	150/150	9/3
	CDS8533	4118523	3-comp. black polypropylene base and 3-comp. clear polypropylene anti-fog lid vented microwavable combo pack	21/6/6 oz. 620/177/177 ml	8.46" x 8.46" x 2.50" 21.5 cm x 21.5 cm x 6.4 cm	19.2 lbs. 8.7 kg	3.01 ft ³ .09 m ³	150/150	9/3
	CDS8531	4118531	3-comp. black polypropylene base and 1-comp. clear polypropylene anti-fog lid vented microwavable combo pack	21/6/6 oz. 620/177/177 ml	8.46" x 8.46" x 2.50" 21.5 cm x 21.5 cm x 6.4 cm	18.2 lbs. 8.3 kg	4.85 ft ³ .14 m ³	150/150	9/3

MICROLITE®



Performance features include:
microwave, heat-lamp, fresh case, cold case



Deli Cups & Lids

	Product Number	SKU Number	Description	Capacity (oz. /ml)	Dimensions	Case Wt. (lb/kg)	Case Cube (ft ³ /m ³)	Case Pack	TI/ HI
	D08CR	D08CR	Clear Polypropylene Deli Tub	8 oz. 237 ml	4.56" x 1.72" 11.6 cm x 4.4 cm	9.37 lbs. 4.3 kg	1.74 ft ³ .05 m ³	500	8/7
	D12CXL	D12CXL	Clear Polypropylene Deli Tub	12 oz. 355 ml	4.56" x 2.67" 11.6 cm x 6.8 cm	11.66 lbs. 5.3 kg	1.98 ft ³ .06 m ³	500	8/6
	D16CXL	D16CXL	Clear Polypropylene Deli Tub	16 oz. 473 ml	4.56" x 3.38" 11.6 cm x 8.6 cm	13.88 lbs. 6.3 kg	2.03 ft ³ .06 m ³	500	8/6
	D24CR	D24CR	Clear Polypropylene Deli Tub	24 oz. 710 ml	4.56" x 4.14" 11.6 cm x 10.5 cm	17.99 lbs. 8.2 kg	3.20 ft ³ .09 m ³	500	8/4
	D32CXL	D32CXL	Clear Polypropylene Deli Tub	32 oz. 946 ml	4.56" x 5.96" 11.6 cm x 15.1 cm	21.04 lbs. 9.5 kg	3.27 ft ³ .09 m ³	500	8/4
	L409C	L409C	Clear Polypropylene Lid	-	4.66" x .26" 11.8 cm x .70 cm	6.09 lbs. 2.7 kg	1.57 ft ³ .04 m ³	500	8/8
	IL409C	IL409C	Clear PE Injection-Molded Lid	-	4.66" x .26" 11.8 cm x .70 cm	10.84 lbs. 4.9 kg	1.86 ft ³ .05 m ³	500	8/7

Combo Packs

	Product Number	SKU Number	Description	Capacity (oz. /ml)	Dimensions	Case Wt. (lb/kg)	Case Cube (ft ³ /m ³)	Case Pack	TI/ HI
	CD08CR	CD08CR	Clear Polypropylene Deli Tub Clear Polypropylene Lid	8 oz. 237 ml	4.56" x 1.72" 11.6 cm x 4.4 cm	7.77 lbs. 4.3 kg	1.74 ft ³ .05 m ³	250/ 250	8/7
	CD12CXL	CD12CXL	Clear Polypropylene Deli Tub Clear Polypropylene Lid	12 oz. 355 ml	4.56" x 2.67" 11.6 cm x 6.8 cm	8.96 lbs. 4.1 kg	1.98 ft ³ .06 m ³	250/ 250	8/6
	CD16CXL	CD16CXL	Clear Polypropylene Deli Tub Clear Polypropylene Lid	16 oz. 473 ml	4.56" x 3.38" 11.6 cm x 8.6 cm	10.07 lbs. 4.6 kg	2.03 ft ³ .06 m ³	250/ 250	8/6
	CD32CXL	CD32CXL	Clear Polypropylene Deli Tub Clear Polypropylene Lid	32 oz. 946 ml	4.56" x 5.96" 11.6 cm x 15.1 cm	13.90 lbs. 6.3 kg	3.07 ft ³ .09 m ³	250/ 250	6/6

CRYSTALCLEAR™



Performance features include:
fresh case, cold case, freezer case
(except as indicated)

Hinged Containers

with Consumer-Friendly, Tear-Away Lid
and Anti-fog technology in cold temperatures



	Product Number	SKU Number	Description	Capacity (oz./ml)	Dimensions	Case Wt. (lb/kg)	Case Cube (ft ³ /m ³)	Case Pack	TI/ HI
	GC600S	4776501	6" RPET shallow container, w/black base; hinged tear-away clear lid w/integral cold anti-fog technology	14 oz. 414 ml	6.63" x 2.44" 16.8 cm x 6.2 cm	11.95 lbs. 5.4 kg	2.29 ft ³ .06 m ³	200	6/7
	GC600D	4776502	6" RPET deep container, w/black base; hinged tear-away clear lid w/integral cold anti-fog technology	18 oz. 532 ml	6.63" x 2.84" 16.8 cm x 7.2 cm	13.14 lbs. 6.0 kg	2.28 ft ³ .06 m ³	200	6/7
	GC750S	4777501	7.5" RPET shallow container, w/black base; hinged tear-away clear lid w/integral cold anti-fog technology	20 oz. 591 ml	7.88" x 2.39" 20.1 cm x 6.1 cm	8.68 lbs. 3.9 kg	1.74 ft ³ .05 m ³	100	9/5
	GC750D	4777502	7.5" RPET deep container, w/black base; hinged tear-away clear lid w/integral cold anti-fog technology	26 oz. 769 ml	7.88" x 2.80" 20.1 cm x 7.1 cm	9.54 lbs. 4.3 kg	1.84 ft ³ .05 m ³	100	9/5
	GC900S	4779501	9" RPET shallow container, w/black base; hinged tear-away clear lid w/integral cold anti-fog technology	30 oz. 887 ml	9.5" x 2.01" 24.1 cm x 5.1 cm	12.52 lbs. 5.7 kg	2.53 ft ³ .07 m ³	100	7/4
	GC900D	4779502	9" RPET deep container, w/black base; hinged tear-away clear lid w/integral cold anti-fog technology	40 oz. 1183 ml	9.5" x 2.80" 24.1 cm x 7.1 cm	14.11 lbs. 6.4 kg	2.54 ft ³ .07 m ³	100	7/5

3-compartment Hinged Container

	GC950C3*	4759503	9.5" 3-comp. PS container w/black base and hinged clear 3-comp. lid	23/7/7 oz. 680/207 207 ml	9.5" x 2.13" 24.1 cm x 5.4 cm	15.64 lbs. 7.1 kg	3.62 ft ³ .10 m ³	100	6/4
--	----------	---------	---	---------------------------------	----------------------------------	----------------------	--	-----	-----

*PS container does not include anti-fog tear-away lid

6" Round CP600 Series



	Product Number	SKU Number	Description	Capacity (oz. /ml)	Dimensions	Case Wt. (lb/kg)	Case Cube (ft ³ /m ³)	Case Pack	TI/ HI
	CP608	4540608	6" Low-profile round RPET black bowl	8 oz. 237 ml	5.9" x 1.13" 15 cm x 2.9 cm	15.70 lbs. 7.1 kg	2.44 ft ³ .07 m ³	500	7/5
	CP612	4540612	6" Low-profile round RPET black bowl	12 oz. 355 ml	5.9" x 1.74" 15 cm x 4.4 cm	17.03 lbs. 7.7 kg	2.50 ft ³ .07 m ³	500	7/5
	CP616	4540616	6" Low-profile round RPET black bowl	16 oz. 473 ml	5.9" x 2.14" 15 cm x 5.4 cm	19.39 lbs. 8.8 kg	2.39 ft ³ .07 m ³	500	8/5
	CP600	4300600	6" round RPET clear lid for 6" Bowls	-	5.9" x .9" 15 cm x 2.3 cm	11.61 lbs. 5.3 kg	2.27 ft ³ .06 m ³	500	8/5

7" Round CP700 Series



	Product Number	SKU Number	Description	Capacity (oz. /ml)	Dimensions	Case Wt. (lb/kg)	Case Cube (ft ³ /m ³)	Case Pack	TI/ HI
	CP724	4400247	7" Classic round PETE black bowl	24 oz. 710 ml	7" x 2.56" 17.8 cm x 6.5 cm	8.16 lbs. 3.7 kg	1.10 ft ³ .03 m ³	150	12/4
	CP724C	4400246	7" Classic round PETE clear bowl	24 oz. 710 ml	7" x 2.56" 17.8 cm x 6.5 cm	8.16 lbs. 3.7 kg	1.10 ft ³ .03 m ³	150	12/4
	CP732	4400327	7" Classic round PETE black bowl	32 oz. 946 ml	7" x 3.06" 17.8 cm x 7.8 cm	8.16 lbs. 3.7 kg	1.17 ft ³ .03 m ³	150	12/4
	CP700	4400207	7" round clear PETE lid for 7" Bowls	-	7" x .75" 17.8 cm x 1.9 cm	5.29 lbs. 2.4 kg	.80 ft ³ .02 m ³	150	18/4

8.5" Round CP8500 Series



	Product Number	SKU Number	Description	Capacity (oz. /ml)	Dimensions	Case Wt. (lb/kg)	Case Cube (ft ³ /m ³)	Case Pack	TI/ HI
	CP8524	4548425	8.5" Low-profile round RPET black bowl	24 oz. 710 ml	8.5" x 1.73" 21.6 cm x 4.4 cm	16.14 lbs. 7.32 kg	3.36 ft ³ .10 m ³	300	4/7
	CP8532	4548432	8.5" Low-profile round RPET black bowl	32 oz. 946 ml	8.5" x 2.14" 21.6 cm x 5.4 cm	19.45 lbs. 8.8 kg	3.42 ft ³ .10 m ³	300	4/6
	CP8548	4408549	8.5" Low-profile round PETE black bowl	48 oz. 1419 ml	8.5" x 2.81" 21.6 cm x 7.1 cm	13.23 lbs 6.0 kg	1.95 ft ³ .06 m ³	150	6/6
	CP8548C	4408548	8.5" Low-profile round PETE clear bowl	48 oz. 1419 ml	8.5" x 2.81" 21.6 cm x 7.1 cm	13.23 lbs 6.0 kg	1.95 ft ³ .06 m ³	150	6/6
	CP8500	4308425	8.5" round RPET clear lid for 8.5" Bowls	-	8.5" x 1.14" 21.6 cm x 2.8 cm	14.70 lbs. 6.7 kg	3.01 ft ³ .09 m ³	300	4/7
	CDCP8524	4118524	8.5" Low-profile round RPET black bowl and clear lid combo pack	24 oz. 710 ml	See component parts	14.62 lbs. 6.6 kg	3.36 ft ³ .10 m ³	150/ 150	4/7

6" Square CPS600 Series



	Product Number	SKU Number	Description	Capacity (oz. /ml)	Dimensions	Case Wt. (lb/kg)	Case Cube (ft ³ /m ³)	Case Pack	TI/ HI
	CPS608	4546008	6" Square Shallow RPET Black Bowl	8 oz. 237 ml	5.9" x 5.9" x 1.11" 14.9 cm x 14.9 cm x 2.8 cm	12.15 lbs. 5.51 kg	2.07 ft ³ .06 m ³	500	8/5
	CPS612	4546012	6" Square Medium RPET Black Bowl	12 oz. 355 ml	5.9" x 5.9" x 1.5" 14.9 cm x 14.9 cm x 3.8 cm	13.16 lbs. 5.97 kg	2.07 ft ³ .06 m ³	500	8/5
	CPS616	4546016	6" Square Deep RPET Black Bowl	16 oz. 473 ml	5.9" x 5.9" x 2.02" 14.9 cm x 14.9 cm x 5.1 cm	14.15 lbs. 6.4 kg	2.25 ft ³ .06 m ³	500	8/5
	CPS6CD	4300610	Clear anti-fog RPET dome lid for 6" square bowls	-	5.9" x 5.9" x .97" 14.9 cm x 14.9 cm x 2.5 cm	11.92 lbs. 5.41 kg	2.01 ft ³ .06 m ³	500	9/5
	CPS6CF	4300601	Clear anti-fog RPET flat lid for 6" square bowls	-	5.9" x 5.9" x .34" 14.9 cm x 14.9 cm x .86 cm	11.10 lbs. 5.03 kg	1.80 ft ³ .05 m ³	500	9/5

7" Square CPS700 Series



	Product Number	SKU Number	Description	Capacity (oz. /ml)	Dimensions	Case Wt. (lb/kg)	Case Cube (ft ³ /m ³)	Case Pack	TI/ HI
	CPS712	4547012	7" low-profile square RPET black bowl	12 oz. 355 ml	6.85" x 6.85" x 1.19" 17.4 cm x 17.4 cm x 3 cm	16.71 lbs. 7.58 kg	2.49 ft ³ .07 m ³	500	5/6
	CPS716	4547017	7" low-profile square RPET black bowl	16 oz. 473 ml	6.85" x 6.85" x 1.55" 17.4 cm x 17.4 cm x 3.9 cm	18.29 lbs. 8.30 kg	2.60 ft ³ .07 m ³	500	5/6
	CPS724	4547024	7" low-profile square RPET black bowl	24 oz. 710 ml	6.85" x 6.85" x 2.22" 17.4 cm x 17.4 cm x 5.6 cm	21.39 lbs. 9.70 kg	2.84 ft ³ .08 m ³	500	5/6
	CPS700	4300701	7" square RPET clear dome lid for 7" bowls	-	6.85" x 6.85" x .97" 17.4 cm x 17.4 cm x 2.5 cm	17.02 lbs. 7.72 kg	2.63 ft ³ .06 m ³	500	5/6

8" Square CPS800 Series



	Product Number	SKU Number	Description	Capacity (oz. /ml)	Dimensions	Case Wt. (lb/kg)	Case Cube (ft ³ /m ³)	Case Pack	TI/ HI
	CPS820	4540820	8" Low-profile square RPET black bowl	24 oz. 710 ml	8.13" x 8.13" x 1.42" 20.6 cm x 20.6 cm x 3.6 cm	8.53 lbs. 3.9 kg	1.13 ft ³ .03 m ³	150	16/5
	CP832	4548100	8" Low-profile square RPET black bowl	32 oz. 946 ml	8.13" x 8.13" x 1.75" 20.6 cm x 20.6 cm x 4.4 cm	9.72 lbs. 4.4 kg	1.31 ft ³ .04 m ³	150	6/10
	CPS848	4540848	8" Low-profile square RPET Black bowl	48 oz. 1419 ml	8.13" x 8.13" x 2.89" 20.6 cm x 20.6 cm x 7.3 cm	11.58 lbs. 5.3 kg	1.39 ft ³ .04 m ³	150	10/5
	CPS848C	4540849	8" Low-profile square RPET clear bowl	48 oz. 1419 ml	8.13" x 8.13" x 2.89" 20.6 cm x 20.6 cm x 7.3 cm	11.58 lbs. 5.3 kg	1.39 ft ³ .04 m ³	150	10/5
	CP800	4308100	8" square RPET clear dome lid for 8" bowls	-	8.13" x 8.13" x 1.36" 20.6 cm x 20.6 cm x 3.5 cm	9.45 lbs. 4.3 kg	1.24 ft ³ .04 m ³	150	6/10
	CPS8CF	4308115	8" square RPET clear flat lid for 8" bowls	-	8.13" x 8.13" x .34" 20.6 cm x 20.6 cm x .9 cm	6.84 lbs. 3.1 kg	1.16 ft ³ .03 m ³	150	8/10



Small Rectangle DV4000 Series

	Product Number	SKU Number	Description	Capacity (oz./ml)	Dimensions	Case Wt. (lb/kg)	Case Cube (ft ³ /m ³)	Case Pack	TI/ HI
	DV4024°	4540242	Clear RPET rectangular deli container	24 oz. 710 ml	8.75" x 6.31" x 1.31" 22.2 cm x 16 cm x 3.3 cm	14.47 lbs. 6.6 kg	2.08 ft ³ .06 m ³	250	8/5
	DV4032°	4540322	Clear RPET rectangular deli container	32 oz. 946 ml	8.75" x 6.31" x 2.0" 22.2 cm x 16 cm x 5.1 cm	14.44 lbs. 6.5 kg	2.08 ft ³ .06 m ³	250	8/5
	L4000°	4304006	Clear RPET flat lid for DV4024 and DV4032	-	8.75" x 6.31" x .25" 22.2 cm x 16 cm x .6 cm	11.01 lbs. 5.0 kg	2.08 ft ³ .06 m ³	250	8/5

°Non-stocking. Call for lead times.

Square DV5000 Series

	DV5008°	4550080	Clear RPET deli container, square	8 oz. 234 ml	5.38" x 5.38" x 1.0" 13.7 cm x 13.7 cm x 2.5 cm	9.22 lbs. 4.2 kg	1.98 ft ³ .06 m ³	500	5/8
	DV5012°	4550120	Clear RPET deli container, square	12 oz. 355 ml	5.38" x 5.38" x 1.5" 13.7 cm x 13.7 cm x 3.8 cm	11.64 lbs. 5.3 kg	2.01 ft ³ .06 m ³	500	5/8
	DV5016°	4550160	Clear RPET deli container, square	16 oz. 473 ml	5.38" x 5.38" x 2.13" 13.7 cm x 13.7 cm x 5.4 cm	12.5 lbs. 5.7 kg	2.1 ft ³ .06 m ³	500	5/8
	L5000°	4305000	Clear RPET flat lid for DV5008, DV5012, and DV5016	-	5.38" x 5.38" x .25" 13.7 cm x 13.7 x .6 cm	9.25 lbs. 4.2 kg	1.91 ft ³ .06 m ³	500	6/8
	L5005°	4305005	Clear RPET dome lid for DV5008, DV5012, and DV5016	-	5.38" x 5.38" x .50" 13.7 cm x 13.7 x 1.3 cm	10.95 lbs. 5.0 kg	1.91 ft ³ .06 m ³	500	5/8

°Non-stocking. Call for lead times.

Large Rectangle DV8000 Series

	DV8010	4581801	Clear RPET rectangular deli medium entree container	29.5 oz. 872 ml	9.5" x 5.88" x 1.38" 24.1 cm x 14.9 cm x 3.5 cm	13.58 lbs. 6.2 kg	1.95 ft ³ .06 m ³	250	8/6
	DV8012°	4581802	Clear RPET rectangular deli 2-compartment container	19/9.5 oz. 562/281 ml	9.5" x 5.88" x 1.38" 24.1 cm x 14.9 cm x 3.5 cm	10.55 lbs. 4.8 kg	1.95 ft ³ .06 m ³	250	8/6
	DV8013	4581803	Clear RPET rectangular deli 3-compartment container	18/4/4 oz. 532/118/ 118 ml	9.5" x 5.88" x 1.38" 24.1 cm x 14.9 cm x 3.5 cm	11.66 lbs. 5.3 kg	1.95 ft ³ .06 m ³	250	8/6
	DV8048	4581805	Clear RPET rectangular, Large, deep deli container	48 oz. 1419 ml	9.5" x 5.88" x 2.50" 24.1 cm x 14.9 cm x 6.4 cm	15.41 lbs. 7.0 kg	1.95 ft ³ .06 m ³	250	8/6
	L8000	4380000	Clear RPET flat lid for DV8010, DV8012, DV8013 and DV8048	-	9.5" x 5.88" x .25" 24.1 cm x 14.9 cm x .6 cm	11.41 lbs. 5.2 kg	1.53 ft ³ .04 m ³	250	12/4
	L8005	4380005	Clear RPET dome lid for DV8010, DV8012, DV8013, DV8048	-	9.5" x 5.88" x 1.5" 24.1 cm x 14.9 cm x 3.8 cm	11.36 lbs. 5.2 kg	1.95 ft ³ .06 m ³	250	7/7

°Non-stocking. Call for lead times.





Deli View™
by Anchor Packaging





Hinged-Lid Containers



Sandwich Wedges Hinged

	Product Number	SKU Number	Description	Capacity (oz./ml)	Dimensions	Case Wt. (lb/kg)	Case Cube (ft ³ /m ³)	Case Pack	TI/HI
	DV1101	4511019	Sandwich wedge with clear hinged lid and clear base (RPET)	-	6.63" x 3.56" x 3.52" 16.8 cm x 9 cm x 8.9 cm	12.72 lbs. 5.8 kg	1.92 ft ³ .05 m ³	250	7/7
	DVH1101B	4511017	Sandwich wedge with clear hinged lid and black base (RPET)	-	6.63" x 3.56" x 3.52" 16.8 cm x 9 cm x 8.9 cm	15.18 lbs. 6.9 kg	1.92 ft ³ .05 m ³	250	7/7

Square & Rectangle Clear Hinged

	Product Number	SKU Number	Description	Capacity (oz./ml)	Dimensions	Case Wt. (lb/kg)	Case Cube (ft ³ /m ³)	Case Pack	TI/HI
	DV3708	4065179	Clear RPET deep polygon hinged deli container	8 oz. 237 ml	5" x 5.96" x 2.0" 12.7cm x 15.1cm x 5.1cm	16.61 lbs 7.5 kg	2.28 ft ³ .06 m ³	250	5/7
	DV3712	4088743	Clear RPET deep polygon hinged deli container	12 oz. 355 ml	5" x 7.21" x 2.0" 12.7cm x 18.3cm x 5.1cm	19.28 lbs. 8.7 kg	2.65 ft ³ .08 m ³	250	5/6
	DV3716	4090780	Clear RPET deep polygon hinged deli container	16 oz. 843 ml	5" x 8.46" x 2.0" 12.7cm x 21.5cm x 5.1cm	22.32 lbs. 10.1 kg	3.16 ft ³ .09 m ³	250	5/5
	FV4800°	FV4800	Clear RPET rectangular hinged hoagie container	-	5.18" x 9" x 3.25" 13.2 cm x 22.9 cm x 8.3 cm	15.40 lbs. 7.0 kg	2.48 ft ³ .07 m ³	200	8/4
	FV8800°	4408800	Clear RPET square hinged container	-	8.25" x 8.25" x 2.88" 20.9cm x 20.9cm x 7.3cm	18.64 lbs. 8.5 kg	3.65 ft ³ .10 m ³	200	4/5

°Non-stocking. Call for lead times.

Round Clear Hinged

	Product Number	SKU Number	Description	Capacity (oz./ml)	Dimensions	Case Wt. (lb/kg)	Case Cube (ft ³ /m ³)	Case Pack	TI/HI
	DV800S°	4768001	Clear RPET polygon hinged deli container	22 oz. 651 ml	8" x 1.88" 20.3 cm x 4.8 cm	14.6 lbs 6.6 kg	2.62 ft ³ .07 m ³	100	6/5

°Non-stocking. Call for lead times.

BONFAIRE®





Performance features include:
fresh case, cold case
(except as indicated)

Hinged Snack Tray







	Product Number	SKU Number	Description	Dimensions	Case Wt. (lb/kg)	Case Cube (ft ³ /m ³)	Case Pack	TI/HI
	BF3600	4093708	Black PS base snack tray with hinged clear lid and textured bottom	5.2" x 6.0" x 2.25" 13.3 cm x 15.2 cm x 5.7 cm	9.8 lbs. 4.4 kg	1.88 ft ³ 0.05 m ³	200	8/3

Hinged Full Meal Trays



	Product Number	SKU Number	Description	Dimensions	Case Wt. (lb/kg)	Case Cube (ft ³ /m ³)	Case Pack	TI/HI
	BF1000 ^o	4010567	Blue PS base full meal tray with hinged clear lid and top loading hot entree dish cavity	11.0" x 8.0" x 2.0" 27.9 cm x 20.3 cm x 5.1 cm	22.78 lbs. 10.4 kg	4.18 ft ³ 0.13 m ³	200	6/2
	BF1102	4020594	Black PS base full meal tray with hinged clear lid and flat bottom	11.0" x 8.0" x 2.0" 27.9 cm x 20.3 cm x 5.1 cm	25.03 lbs. 11.4 kg	5.02 ft ³ 0.14 m ³	200	6/2

^oNon-stocking. Call for lead times.

Executive Meals

	Product Number	SKU Number	Description	Dimensions	Case Wt. (lb/kg)	Case Cube (ft ³ /m ³)	Case Pack	TI/HI
	BF5200	4028217	Black PS executive meal base	10.13" x 10.13" x 2.0" 25.7 cm x 25.7 cm x 5.1 cm	9.76 lbs. 4.4 kg	2.16 ft ³ 0.06 m ³	50	6/6
	BF5215	4096784	Black PS executive meal tray insert for BF5200 with triangular and rectangular compartments	9.50" x 9.56" x 1.25" 24.1 cm x 24.3 cm x 3.2 cm	5.30 lbs. 2.4 kg	1.93 ft ³ .05 m ³	50	6/6
	BF5216	4080442	Black PS executive meal tray insert for BF5200 with square and rectangular compartments	9.50" x 9.56" x 1.25" 24.1 cm x 24.3 cm x 3.2 cm	5.30 lbs. 2.4 kg	1.93 ft ³ .05 m ³	50	6/6
	BF5250	4064621	Clear PS executive meal tray lid for BF5200	10.10" x 10.10" x 1.38" 25.7 cm x 25.7 cm x 3.5 cm	8.32 lbs. 3.8 kg	2.16 ft ³ 0.06 m ³	50	6/6

Accessories

	Product Number	SKU Number	Description	Dimensions	Case Wt. (lb/kg)	Case Cube (ft ³ /m ³)	Case Pack	TI/HI
	BF6200	4021614	White PS square insert dish	3" x 3" x 1.25" 7.6 cm x 7.6 cm x 3.2 cm	10.32 lbs. 4.7 kg	1.49 ft ³ .04 m ³	1000	5/6
	BF9800C*	4051900	White coated inside aluminum casserole	6.25" x 4" x 1.0" 15.9 cm x 10.2 cm x 2.5 cm	26 lbs. 11.8 kg	1.66 ft ³ .05 m ³	1000	6/7
	BF9061M ^o	4045044	White PS cutlery kit (6 in 1: medium weight knife, fork, spoon, napkin, salt, pepper)	-	19 lbs. 8.6 kg	2.81 ft ³ .08 m ³	500	9/5

*Ovenable and freezer safe. ^oNon-stocking. Call for lead times.

ANCHORFOIL™







Performance features include:
oven, heat lamp, cold case, freezer case

Foil Pans & Lids

Half & Full Steamtables



	Product Number	SKU Number	Product Description	Product Dimension	Capacity (oz./ml)	Case weight (lb/kg)	Case Cube (ft ³ /m ³)	Case Pack	TI/ HI
	AFP10133	6404121	Steam Table Pan, Half, Deep, Full Curl Edge	10.38" x 12.75" x 2.56" 26.4cm x 32.4cm x 6.5cm	120 oz. 3548ml	10.5 lbs 4.8 kg	2.24 ft ³ .07 m ³	100	4/7
	AFP1013L	6404000	Foil lid for Steam Table Pan, Half	10.56" x 13" .63" 26.8cm x 33cm x 1.6cm	-	6.6 lbs 3.0 kg	.87 ft ³ .03 m ³	100	9/7
	AFP21133	6404202	Steam Table Pan, Full, Deep, Full Curl Edge	12.81" x 20.75" x 3.38" 32.5cm x 52.7cm x 8.6cm	346 oz. 10,229 ml	15.10 lbs 6.85 kg	2.18 ft ³ .07 m ³	50	7/5
	AFP2113L	6404001	Foil lid for Steam Table Pan, Full	12.88" x 20.81" x .63" 32.7cm x 52.9cm x 1.6cm	-	8.6 lbs 3.9 kg	.94 ft ³ .03 m ³	50	5/12



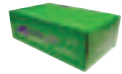
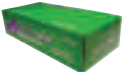

Foil Pop-Up Sheets



	AFS911	6403910	9" x 10.75" 22.9 cm x 27.3 cm (500 sheets per box)	18.5" x 10.75" x 7.5" 47cm x 27.3cm x 19.1cm	14.14 lbs 6.4 kg	.82 ft ³ .02 m ³	6	8/6
	AFS1211	6403220	12" x 10.75" 30.5 cm x 27.3 cm (200 sheets per box)	24" x 13.25" x 8.25" 61cm x 33.6cm x 21cm	15.13 lbs 6.9 kg	1.19 ft ³ .03 m ³	12	6/6

Foil Rolls



	AF121S	6401121	Standard	12" x 1000' 30.5cm x 304.8m	8.15 lbs 3.7 kg	.15 ft ³ .004 m ³	1	24/8
	AF185S	6401185	Standard	18" x 500' 45.7cm x 152.4m	6.40 lbs 3.0 kg	.22 ft ³ .007 m ³	1	20/8
	AF181S	6401181	Standard	18" x 1000' 45.7cm x 304.8m	12.21 lbs 5.5 kg	.22 ft ³ .007 m ³	1	20/8
	AF185H	6402185	Heavy-Duty	18" x 500' 45.7cm x 152.4m	8.89 lbs 4.0 kg	.22 ft ³ .007 m ³	1	20/8
	AF181H	6402181	Heavy-Duty	18" x 1000' 45.7cm x 304.8m	17.53 lbs 8.0 kg	.30 ft ³ .009 m ³	1	16/8

Foodservice Film & Foil: Quick Reference Chart

BRAND	WIDTH (inches)																Page					
	6	7	8	9	10	11	12	13	14	15	16	17	18	19	20	21		22	23	24	30	36
CLING FILMS																						
AnchorWrap™							X						X						X			29
CheeseGuard							X															30
CrystalWrap™							X						X						X			29
CrystalWrap™ Plus							X						X									29
E15 (perforated sheets)	X	X	X	X	X	X	X		X	X	X		X				X		X			32
Miler®							X			X			X						X			30
PurityWrap™						X	X			X		X	X						X			28
ValueWrap™							X						X						X			30
SHRINK FILMS																						
E9 (perforated sheets)							X		X	X	X	X	X		X		X		X	X	X	33
Pizza (perforated sheets)											X		X		X		X		X	X		34
STRETCH FILMS																						
UltraWrap™ Automatic Meat						X	X		X	X		X	X	X								36
UltraWrap™ Miler													X									37
UltraWrap™ Premium Meat/Poultry										X		X	X	X	X							36
UltraWrap™ Pro Freezer										X			X									36
UltraWrap™ Produce									X	X		X	X									37
UltraWrap™ Stretch							X	X	X	X	X	X	X	X	X	X						37
ANCHORFOIL™																						
Popup Sheets (10.75")				X			X															25
Cutter Boxes (Standard Gauge)							X						X									25
Cutter Boxes (Heavy Gauge)													X									25

Foodservice CLING WRAP



Performance features include:
fresh case, cold case



Premium-Grade

Cling Wrap Cutterboxes



Product Number	SKU Number	Dimensions	Case Wt. (lb/kg)	Case Cube (ft ³ /m ³)	Case Pack	TI/HI
PW121	7309421	12" x 1,000' 30.48 cm x 304.8 m	3.97 lbs. 1.8 kg	.30 ft ³ .01 m ³	1	48/3
PW122	7309422	12" x 2,000' 30.48 cm x 609.6 m	6.37 lbs. 2.9 kg	.30 ft ³ .01 m ³	1	48/3
PW123	7309423	12" x 3,000' 30.48 cm x 914.4 m	8.93 lbs. 4.1 kg	.30 ft ³ .01 m ³	1	48/3
PW152	7309452	15" x 2,000' 38.1 cm x 609.6 m	7.78 lbs. 3.5 kg.	.37 ft ³ .01 m ³	1	48/2
PW181	7309481	18" x 1,000' 45.72 cm x 304.8 m	5.59 lbs. 2.5 kg	.41 ft ³ .01 m ³	1	48/2
PW182	7309482	18" x 2,000' 45.72 cm x 609.6 m	8.46 lbs. 3.8 kg	.41 ft ³ .01 m ³	1	48/2
PW183	7309483	18" x 3,000' 45.72 cm x 914.4 m	13 lbs. 5.9 kg	.41 ft ³ .01 m ³	1	48/2
PW242	7309442	24" x 2,000' 60.96 cm x 609.6 m	11.98 lbs. 5.4 kg	.51 ft ³ .01 m ³	1	48/1

Canadian Purity Wrap™

Product Number	SKU Number	Description	Dimensions	Case Wt. (lb/kg)	Case Cube (ft ³ /m ³)	Case Pack	TI/HI
7303512	7303512	Single-pack cutter box	11" x 2,500' 27.94 cm x 762 m	6.77 lbs. 3.8 kg	.30 ft ³ .01 m ³	1	48/3
7303572	7303572	Single-pack cutter box	17" x 2,500' 43.18 cm x 762 m	10.03 lbs. 4.5 kg	.43 ft ³ .01 m ³	1	48/2
7303412	7303412	3-pack refill rolls	11" x 2,000' 27.94 cm x 609.6 m	16.93 lbs. 7.7 kg	.68 ft ³ .02 m ³	3	19/3
7303472	7303472	3-pack refill rolls	17" x 2,000' 43.18 cm x 609.6 m	24.79 lbs. 11.2 kg.	.85 ft ³ .02 m ³	3	19/2

Purity Wrap™ Safety Cutters

Product Number	SKU Number	Dimensions	Case Wt. (lb/kg)	Case Cube (ft ³ /m ³)	Case Pack	TI/HI
6503412	6503412	12" 30.5 cm	1.7 lbs. .8 kg	.27 ft ³ .01 m ³	30	1/1
6503512	6503512	12" 30.5 cm	.04 lbs. .001 kg	-	1	1/1
6503418	6503418	18" 45.7 cm	2.4 lbs. 1.1 kg	.35 ft ³ .01 m ³	30	1/1
6503518	6503518	18" 45.7 cm	.06 lbs. .002 kg	-	1	1/1
6503524	6503524	24" 61.0 cm	.08 lbs. .002 kg	-	1	1/1



Premium-Grade Cling Wrap Cutterboxes



Product Number	SKU Number	Dimensions	Case Wt. (lb/kg)	Case Cube (ft ³ /m ³)	Case Pack	TI/HI
AW122	7318512	12" x 2,000' 30.48 cm x 609.6 m	6.11 lbs. 2.8 kg	.30 ft ³ .01 m ³	1	48/3
AW182	7318518	18" x 2,000' 45.72 cm x 609.6 m	8.8 lbs. 4.0 kg	.43 ft ³ .01 m ³	1	48/2
AW242	7318524	24" x 2,000' 60.96 cm x 609.6 m	11.46 lbs. 5.2 kg	.53 ft ³ .02 m ³	1	48/1

Refill Rolls

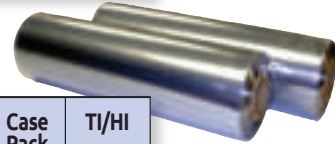

Product Number	SKU Number	Dimensions	Case Wt. (lb/kg)	Case Cube (ft ³ /m ³)	Case Pack	TI/HI
7303223*	7303223 ^o	12" x 3,000' 30.48 cm x 914.4 m	15.53 lbs. 7.0 kg	.46 ft ³ .01 m ³	2	56/3
7303283*	7303283 ^o	18" x 3,000' 45.72 cm x 914.4 m	23.1 lbs. 10.5 kg	.66 ft ³ .02 m ³	2	56/2

^oNon-stocking. Call for lead times. *Slide cutters are available only in the AnchorWrap Cutter boxes. Dispensers for your bulk refill rolls also available.



Heavy-Duty Cling Wrap Cutterboxes



Product Number	SKU Number	Dimensions	Case Wt. (lb/kg)	Case Cube (ft ³ /m ³)	Case Pack	TI/HI
CW122	7301235	12" x 2,000' 30.48 cm x 609.6 m	6.11 lbs. 2.7 kg	.30 ft ³ .01 m ³	1	48/3
CW123	7301223	12" x 3,000' 30.48 cm x 914.4 m	8.54 lbs. 3.9 kg	.30 ft ³ .01 m ³	1	48/3
CW182	7301835	18" x 2,000' 45.72 cm x 609.6 m	8.8 lbs. 4.0 kg	.43 ft ³ .01 m ³	1	48/2
CW183	7301823	18" x 3,000' 45.72 cm x 914.4 m	12.42 lbs. 5.6 kg	.43 ft ³ .01 m ³	1	48/2
CW242	7302435	24" x 2,000' 60.96 cm x 609.6 m	11.46 lbs. 5.2 kg	.56 ft ³ .02 m ³	1	48/1

Crystal Wrap™ Plus*



Product Number	SKU Number	Dimensions	Case Wt. (lb/kg)	Case Cube (ft ³ /m ³)	Case Pack	TI/HI
CWP123	7302523	12" x 3,000' 30.48 cm x 914.4 m	8.54 lbs. 3.9 kg	.30 ft ³ .01 m ³	1	48/3
CWP183	7302583	18" x 3,000' 45.72 cm x 914.4 m	12.42 lbs. 5.6 kg	.43 ft ³ .01 m ³	1	48/2

*Crystal Wrap Plus cutterboxes include Dri-Gard™. Repels grease and moisture to keep boxes sanitary and sturdy.



Product Number	SKU Number	Dimensions	Case Wt. (lb/kg)	Case Cube (ft ³ /m ³)	Case Pack	TI/HI
VW122	7300112	12" x 2,000' 30.48 cm x 609.6 m	4.82 lbs. 2.2 kg.	.19 ft ³ .01 m ³	1	72/3
VW182	7300118	18" x 2,000' 45.72 cm x 609.6 m	7.15 lbs. 3.2 kg.	.27 ft ³ .01 m ³	1	72/2
VW242	7300124	24" x 2,000' 60.96 cm x 609.6 m	9.45 lbs. 4.3 kg.	.35 ft ³ .01 m ³	1	72/1

Mile of Cling Wrap



Product Number	SKU Number	Dimensions	Case Wt. (lb/kg)	Case Cube (ft ³ /m ³)	Case Pack	TI/HI
MF12	MF12	12" x 5,280' 30.48 cm x 1609.3 m	15.33 lbs. 7.0 kg	.58 ft ³ .02 m ³	1	25/3
MF15	MF15 ^o	15" x 5,280' 38.1 cm x 1609.3 m	19.38 lbs. 8.8 kg	.79 ft ³ .02 m ³	1	25/2
MF18	MF18	18" x 5,280' 45.72 cm x 1609.3 m	22.8 lbs. 10.3 kg	.79 ft ³ .02 m ³	1	25/2
MF24	MF24	24" x 5,280' 60.96 cm x 1609.3 m	30.28 lbs. 13.7 kg	1.03 ft ³ .03 m ³	1	25/1

^oNon-stocking. Call for lead times.

Miler[®] Stainless Steel Speedwrap Dispenser

Product Number	SKU Number	Dimensions	Case Wt. (lb/kg)	Case Cube (ft ³ /m ³)	Case Pack	TI/HI
MD12	6034120	Uses 12" (30.48 cm) wrap	7 lbs. 3.2 kg	.73 ft ³ .21 m ³	1	10/4
MD18	6034180	Uses 18" (45.72 cm) wrap	8.06 lbs. 3.7 kg	.762 ft ³ .02 m ³	1	8/4
MD24	6034240	Uses 24" (60.96 cm) wrap	10 lbs. 4.5 kg	1.4 ft ³ .04 m ³	1	6/4

Cheese Guard - Cling Wrap

Product Number	SKU Number	Dimensions	Case Wt. (lb/kg)	Case Cube (ft ³ /m ³)	Case Pack	TI/HI
CG12	CG12	12" x 2,450' 30.48 cm x 746.8 m	14.21 lbs. 6.4 kg	.53 ft ³ .02 m ³	1	25/3

Perforated FILMS



Performance features include:
fresh case, cold case

E15 Cling Wrap

Dispenser Boxes



Product Number	SKU Number	Dimensions	Sheets Per Roll	Case Wt. (lbs./kg)	Case Cube (ft ³ /m ³)	Case Pack	TI/HI
E1565	E1565	6" x 5" 15.24 cm x 12.7 cm	3,000	2.58 lbs. 1.2 kg	.13 ft ³ .004 m ³	1	50/8
E1588	E1588	8" x 8" 20.32 cm x 20.32 cm	2,400	3.51 lbs. 1.6 kg	.17 ft ³ .005 m ³	1	36/8
E1599	E1599	9" x 9" 22.86 cm x 22.86 cm	2,100	3.8 lbs. 1.7 kg	.17 ft ³ .005 m ³	1	36/8
E151010	E151010	10" x 10" 25.4 cm x 25.4 cm	1,900	4.16 lbs. 1.9 kg	.17 ft ³ .005 m ³	1	36/8
E151111	E151111	11" x 11" 27.94 cm x 27.94 cm	1,700	4.24 lbs. 1.9 kg	.22 ft ³ .01 m ³	1	29/9
E151212	2120120	12" x 12" 30.48 cm x 30.48 cm	1,600	4.69 lbs. 2.1 kg	.22 ft ³ .01 m ³	1	29/8
E151414	E151414	14" x 14" 35.56 cm x 35.56 cm	1,200	5.25 lbs. 2.4 kg	.22 ft ³ .01 m ³	1	24/8
E151515	E151515	15" x 15" 38.1 cm x 38.1 cm	1,100	5.53 lbs. 2.5 kg	.25 ft ³ .01 m ³	1	24/8
E151616 ^o	E151616	16" x 16" 40.6 cm x 40.6 cm	1,100	5.68 lbs. 2.6 kg	.27 ft ³ .01 m ³	1	18/8

^oNon-stocking. Call for lead times.

E15 Cling Wrap

Rolls



Product Number	SKU Number	Dimensions	Sheets Per Roll	Case Wt. (lbs./kg)	Case Cube (ft ³ /m ³)	Case Pack	TI/ HI
E151818	E151818	18" x 18" 45.72 cm x 45.72 cm	900	6.39 lbs. 2.9 kg	.30 ft ³ .01 m ³	1	16/8
E152222 ^o	E152222	22" x 22" 55.9 cm x 55.9 cm	600	6.64 lbs. 3.0 kg	.38 ft ³ .01 m ³	1	12/8
E152418	E152418	24" x 18" 60.96 cm x 45.72 cm	700	8.67 lbs. 3.9 kg	.38 ft ³ .01 m ³	1	12/8
E152428	E152428	24" x 28" 60.96 cm x 71.12 cm	400	5.56 lbs. 2.5 kg	.38 ft ³ .01 m ³	1	12/8

^oNon-stocking. Call for lead times.

E9 Shrink Wrap

Rolls



Product Number	SKU Number	Dimensions	Sheets Per Roll	Case Wt. (lbs./kg)	Case Cube (ft ³ /m ³)	Case Pack	TI/HI
E91212 [◊]	E91212	12" x 12" 30.5 cm x 30.5	1400	5.73 lbs. 2.6 kg	.22 ft ³ .01 m ³	1	29/8
E91414	E91414	14" x 14" 35.6 cm x 35.6 cm	1100	6.22 lbs. 2.8 kg	.25 ft ³ .01 m ³	1	24/8
E91515	E91515	15" x 15" 38.1 cm x 38.1 cm	1000	6.51 lbs. 3 kg	.27 ft ³ .01 m ³	1	24/8
E91616	E91616	16" x 16" 40.6 cm x 40.6 cm	1000	7.26 lbs. 3.3 kg	.27 ft ³ .01 m ³	1	18/8
E91717 [◊]	E91717	17" x 17" 43.2 cm x 43.2 cm	900	7.43 lbs. 3.4 kg	.30 ft ³ .01 m ³	1	16/8
E91818	E91818	18" x 18" 45.7 cm x 45.7 cm	900	8.19 lbs. 3.7 kg	.30 ft ³ .01 m ³	1	16/8
E92021	E92021	20" x 21" 50.8 cm x 53.3 cm	600	7.04 lbs. 3.2 kg	.33 ft ³ .01 m ³	1	16/8
E92222 [◊]	E92222	22" x 22" 55.9 cm x 55.9 cm	600	8.43 lbs. 3.8 kg	.38 ft ³ .01 m ³	1	12/8
E92424 [◊]	E92424	24" x 24" 61 cm x 61 cm	500	8.37 lbs. 3.8 kg	.38 ft ³ .01 m ³	1	12/8
E93030 [◊]	E93030	30" x 30" 76.2 cm x 76.2 cm	200	8.46 lbs. 3.8 kg	.51 ft ³ .01 m ³	1	9/8
E93636	E93636	36" x 36" 91.4 cm x 91.4 cm	200	8.37 lbs. 3.8 kg	.55 ft ³ .02 m ³	1	9/8

◊Non-stocking. Call for lead times.

Pizza Shrink Film

Rolls





Product Number	SKU Number	Dimensions	Sheets Per Roll	Case Wt. (lbs./kg)	Case Cube (ft ³ /m ³)	Case Pack	TI/HI
PZ1616 ^o	PZ1616	16" x 16" 40.6 cm x 40.6 cm	800	5.22 lbs. 2.4 kg	.27 ft ³ .01 m ³	1	18/8
PZ1818 ^o	PZ1818	18" x 18" 45.7 cm x 45.7 cm	700	5.73 lbs. 2.6 kg	.30 ft ³ .01 m ³	1	16/8
PZ2020 ^o	PZ2020	20" x 20" 50.8 cm x 50.8 cm	600	6.10 lbs. 2.8 kg	.33 ft ³ .01 m ³	1	16/8
PZ2222	PZ2222	22" x 22" 55.9 cm x 55.9 cm	500	6.31 lbs. 2.9 kg	.38 ft ³ .01 m ³	1	12/8
PZ24245	PZ24245	24" x 24" 61 cm x 61 cm	500	7.24 lbs. 3.3 kg	.38 ft ³ .01 m ³	1	12/8
2050300	2050300	30" x 30" 76.2 cm x 76.2 cm	300	7.40 lbs. 3.4 kg	.51 ft ³ .01 m ³	1	12/8

^oNon-stocking. Call for lead times.

Pizza Film Size Chart

Pizza Diameter	Wrap Size Needed
8"	16" x 16"
9"	18" x 18"
10"	20" x 20"
12"	22" x 22"
14"	24" x 24"
16"	30" x 30"

Perforated Film Dispensers

	SKU Number	Description	Case Wt. (lbs./kg)	Case Cube (ft ³ /m ³)	Case Pack	TI/HI
	1310000 ^o	One tier dispenser	2 lbs. 0.9 kg	.63 ft ³ .02 m ³	1	1/1
	1320000 ^o	Two tier dispenser	3 lbs. 1.4 kg	.51 ft ³ .01 m ³	1	1/1

^oNon-stocking. Call for lead times.

ULTRAWRAP™



Performance features include:
fresh case, cold case



Product Number	SKU Number	Dimensions	Case Wt. (lb/kg)	Case Cube (ft ³ /m ³)	Case Pack	TI/HI
7051510 ^o	7051510	15" x 3000' 38.1 cm x 914 m	25.74 lbs. 11.7 kg	.72 ft ³ .02 m ³	1	25/2
7051810 ^o	7051810	18" x 3000' 45.7 cm x 914 m	30.82 lbs. 14 kg	.84 ft ³ .02 m ³	1	25/2

^oNon-stocking. Call for lead times.

Premium-Meat & Poultry Film

Product Number	SKU Number	Dimensions	Case Wt. (lb/kg)	Case Cube (ft ³ /m ³)	Case Pack	TI/HI
7041573	7041573	15" x 4000' 38.1 cm x 1219 m	25.11 lbs. 11.4 kg	.72 ft ³ .02 m ³	1	25/2
7041773 ^o	7041773	17" x 4000' 43.2 cm x 1219 m	28.41 lbs. 12.9 kg	.80 ft ³ .02 m ³	1	25/2
7041873	7041873	18" x 4000' 45.7 cm x 1219 m	30.06 lbs. 13.6 kg	.84 ft ³ .02 m ³	1	25/2
7041973	7041973	19" x 4000' 48.3 cm x 1219 m	31.74 lbs. 14.74 kg	.84 ft ³ .02 m ³	1	25/2
7042073 ^o	7042073	20" x 4000' 50.8 cm x 1219 m	33.36 lbs. 15.13 kg	.92 ft ³ .03 m ³	1	25/2

^oNon-stocking. Call for lead times.

Automatic-Meat Film

Product Number	SKU Number	Dimensions	Case Wt. (lb/kg)	Case Cube (ft ³ /m ³)	Case Pack	TI/HI
7031163 ^o	7031163	11" x 5000' 27.94 cm x 1524 m	19.85 lbs. 9.0 kg	.56 ft ³ .02 m ³	1	25/3
7031263 ^o	7031263	12" x 5000' 30.5 cm x 1524 m	21.62 lbs. 9.8 kg	.60 ft ³ .02 m ³	1	25/3
7031463 ^o	7031463	14" x 5000' 35.6 cm x 1524 m	25.16 lbs. 11.4 kg	.68 ft ³ .02 m ³	1	25/2
7031563	7031563	15" x 5000' 38.1 cm x 1524 m	26.93 lbs. 12.2 kg	.72 ft ³ .02 m ³	1	25/2
7031763	7031763	17" x 5000' 43.2 cm x 1524 m	30.48 lbs. 13.8 kg	.80 ft ³ .02 m ³	1	25/2
7031863	7031863	18" x 5000' 45.7 cm x 1524 m	32.25 lbs. 14.6 kg	.84 ft ³ .02 m ³	1	25/2
7031963	7031963	19" x 5000' 48.3 cm x 1524 m	34.05 lbs. 15.4 kg	.88 ft ³ .02 m ³	1	25/2

^oNon-stocking. Call for lead times.



Product Number	SKU Number	Dimensions	Case Wt. (lb/kg)	Case Cube (ft³/m³)	Case Pack	TI/HI
7021260 [◇]	7021260	12" x 5000' 30.5 cm x 1524 m	20.67 lbs. 9.4 kg	.60 ft³ .02 m³	1	25/3
7021360 [◇]	7021360	13" x 5000' 33 cm x 1524 m	22.36 lbs. 10.1 kg	.64 ft³ .02 m³	1	25/3
7021460 [◇]	7021460	14" x 5000' 35.6 cm x 1524 m	24.05 lbs. 10.9 kg	.68 ft³ .02 m³	1	25/2
7021560	7021560	15" x 5000' 38.1 cm x 1524 m	24.91 lbs. 11.3 kg	.66 ft³ .02 m³	1	25/2
7021660	7021660	16" x 5000' 40.6 cm x 1524 m	27.44 lbs. 12.4 kg	.75 ft³ .02 m³	1	25/2
7021760	7021760	17" x 5000' 43.2 cm x 1524 m	28.32 lbs. 12.8 kg	.74 ft³ .02 m³	1	25/2
7021860	7021860	18" x 5000' 45.7 cm x 1524 m	30.72 lbs. 13.9 kg	.78 ft³ .02 m³	1	25/2
7021960	7021960	19" x 5000' 48.3 cm x 1524 m	32.54 lbs. 14.8 kg	.87 ft³ .03 m³	1	25/2
7022060 [◇]	7022060	20" x 5000' 50.8 cm x 1524 m	34.21 lbs. 15.5 kg	.92 ft³ .03 m³	1	25/1
7022160 [◇]	7022160	21" x 5000' 53.3 cm x 1524 m	35.89 lbs. 16.3 kg	.96 ft³ .03 m³	1	25/1

[◇]Non-stocking. Call for lead times.

Ultra Wrap Miler Film

Product Number	SKU Number	Dimensions	Case Wt. (lb/kg)	Case Cube (ft³/m³)	Case Pack	TI/HI
7091850	7091850	18" x 5280' 45.7 cm x 1609 m	28.14 lbs. 12.8 kg	.72 ft³ .02 m³	1	25/2

Produce Film

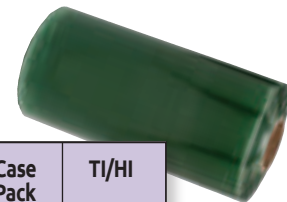

Product Number	SKU Number	Dimensions	Case Wt. (lb/kg)	Case Cube (ft³/m³)	Case Pack	TI/HI
7061458 [◇]	7061458	14" x 5000' 35.6 cm x 1524 m	23.31 lbs. 10.6 kg	.68 ft³ .02 m³	1	25/2
7061558	7061558	15" x 5000' 38.1 cm x 1524 m	24.95 lbs. 11.3 kg	.72 ft³ .02 m³	1	25/2
7061758	7061758	17" x 5000' 43.2 cm x 1524 m	28.23 lbs. 12.8 kg	.80 ft³ .02 m³	1	25/2
7061858	7061858	18" x 5000' 45.7 cm x 1524 m	29.87 lbs. 13.5 kg	.84 ft³ .02 m³	1	25/2

UPC/GTIN Code by Product

Product #	SKU #	Brand	Family	UPC Code	GTIN-14 Code	Page
Polypropylene - Microwavable & Heat-Tolerant (except as indicated)						
4110001	4110001	MicroRaves	Roasters	72184441826 3	00 72184441826 3	5
4110004	4110004	MicroRaves	Roasters	72184441995 6	00 72184441995 6	5
4110005	4110005	MicroRaves	Roasters	72184442207 9	00 72184442207 9	5
4110100	4110100	MicroRaves	Roasters	72184441757 0	00 72184441757 0	5
4110300	4110300	MicroRaves	Roasters	72184442119 5	00 72184442119 5	5
4110600	4110600	MicroRaves	Roasters	72184442354 0	00 72184442354 0	5
4110650	4110650	MicroRaves	Roasters	72184442732 6	00 72184442732 6	5
4489409	4489409	MicroRaves	Hotdog Container	72184441148 6	00 72184441148 6	10
CB690F	4666901	Culinary Series	Crisp Food Container	72184442636 7	00 72184442636 7	13
CB91011B	4669111	Culinary Series	Culinary Basics	72184441969 7	00 72184441969 7	13
CB910F	4669101	Culinary Series	Crisp Food Container	72184442258 1	00 72184442258 1	13
CB9911B	4669911	Culinary Series	Culinary Basics	72184441968 0	00 72184441968 0	13
CC6911	4656911	Culinary Series	Culinary Classics	72184441744 0	00 72184441744 0	12
CC6922	4656922	Culinary Series	Culinary Classics	72184441745 7	00 72184441745 7	12
CC91011B	4659611	Culinary Series	Culinary Classics	72184441288 9	00 72184441288 9	12
CC91031B	4659631	Culinary Series	Culinary Classics	72184441289 6	00 72184441289 6	12
CC91033B	4659633	Culinary Series	Culinary Classics	72184441290 2	00 72184441290 2	12
CC9911B	4659111	Culinary Series	Culinary Classics	72184441285 8	00 72184441285 8	12
CC9931B	4659131	Culinary Series	Culinary Classics	72184441286 5	00 72184441286 5	12
CC9933B	4659133	Culinary Series	Culinary Classics	72184441287 2	00 72184441287 2	12
CD08CR	CD08CR	MicroLite		72184440624 6	00 72184440624 6	15
CD12CXL	CD12CXL	MicroLite		72184440630 7	00 72184440630 7	15
CD16CXL	CD16CXL	MicroLite		72184440626 0	00 72184440626 0	15
CD32CXL	CD32CXL	MicroLite		72184440628 4	00 72184440628 4	15
CDM1185	4111185	MicroRaves	Roasters	72184441897 3	00 72184441897 3	5
CDM408B*	4114080	MicroRaves	M400s	72184441767 9	00 72184441767 9	6
CDM412B*	4114120	MicroRaves	M400s	72184441768 6	00 72184441768 6	6
CDM416B*	4114160	MicroRaves	M400s	72184441837 9	00 72184441837 9	6
CDM416BLH	4114168	MicroRaves	M400s	72184442151 5	00 72184442151 5	6
CDM424B*	4114245	MicroRaves	M400s	72184441836 2	00 72184441836 2	6
CDM424BLH	4114246	MicroRaves	M400s	72184441835 5	00 72184441835 5	6
CDM432B*	4114320	MicroRaves	M400s	72184441840 9	00 72184441840 9	6
CDM432BLH	4114329	MicroRaves	M400s	72184442208 6	00 72184442208 6	6
CDM5816B	4115816	MicroRaves	Incredi-Bowl M5800s	72184442203 1	00 72184442203 1	2
CDM5820B	4115820	MicroRaves	Incredi-Bowl M5800s	72184442204 8	00 72184442204 8	2
CDM5824B	4115824	MicroRaves	Incredi-Bowl M5800s	72184442205 5	00 72184442205 5	2
CDM616B	4111650	MicroRaves	M600s	72184442845 3	00 72184442845 3	6
CDM710/LC710D	4117110*	MicroRaves	M700s	72184442267 3	00 72184442267 3	8
CDM710/LH710D	4117100	MicroRaves	M700s	72184442236 9	00 72184442236 9	8
CDM712/LH710D	4110712	MicroRaves	M700s	72184442355 7	00 72184442355 7	8
CDM713/LH713	4117013	MicroRaves	M700s	72184442645 9	00 72184442645 9	8
CDM8524B	4118500	MicroRaves	Incredi-Bowl M8500s	72184442544 5	00 72184442544 5	3
CDM8527B	4118528	MicroRaves	Incredi-Bowl M8500s	72184442590 2	00 72184442590 2	3
CDM8532B	4118533	MicroRaves	Incredi-Bowl M8500s	72184442317 5	00 72184442317 5	3
CDM912B*	4119120	MicroRaves	M900s	72184441878 2	00 72184441878 2	4
CDM916B*	4119160	MicroRaves	M900s	72184441879 9	00 72184441879 9	4
CDM950D	4119500	MicroRaves	M950	72184441959 8	00 72184441959 8	4
CDMW924B*	4119243	MicroRaves	M900s	72184441508 8	00 72184441508 8	4
CDS8511	4118521	Culinary Series	Culinary Squares	72184442858 3	00 72184442858 3	13
CDS8533	4118523	Culinary Series	Culinary Squares	72184442859 0	00 72184442859 0	13
CDS8531	4118531	Culinary Series	Culinary Squares	72184442857 6	00 72184442857 6	13
CS85321B	4688521	Culinary Series	Culinary Squares	72184442785 2	00 72184442785 2	13
CS85323B	4688523	Culinary Series	Culinary Squares	72184442787 6	00 72184442787 6	13
CS85LH1	4338521	Culinary Series	Culinary Squares	72184442786 9	00 72184442786 9	13
CS85LH3	4338523	Culinary Series	Culinary Squares	72184442788 3	00 72184442788 3	13
D08CR	D08CR	MicroLite		72184440413 6	00 72184440413 6	15
D12CXL	D12CXL	MicroLite		72184440419 8	00 72184440419 8	15
D16CXL	D16CXL	MicroLite		72184440415 0	00 72184440415 0	15
D24CR	D24CR	MicroLite		72184441343 5	00 72184441343 5	15
D32CXL	D32CXL	MicroLite		72184440417 4	00 72184440417 4	15
IL409C	IL409C	MicroLite		72184442150 8	00 72184442150 8	15
L4000*	4304006	MicroRaves	M400s	72184440266 8	00 72184440266 8	6
L409C	L409C	MicroLite		72184440710 6	00 72184440710 6	15
L8000*	4380000	MicroRaves	MW800s	72184440226 2	00 72184440226 2	9
L8005*	4380005	MicroRaves	MW800s	72184440227 9	00 72184440227 9	9
L810PP	4338100	MicroRaves	MW800s	72184441821 8	00 72184441821 8	9
L812PP	4338120	MicroRaves	MW800s	72184441822 5	00 72184441822 5	9
L813PP	4338130	MicroRaves	MW800s	72184441823 2	00 72184441823 2	9

* PETE/PPET; not microwavable or heat resistant

UPC/GTIN Code by Product

Product #	SKU #	Brand	Family	UPC Code	GTIN-14 Code	Page
L9000*	4309000	MicroRaves	M900s	72184440309 2	00 72184440309 2	4
L9024*	4309006	MicroRaves	M900s	72184440251 4	00 72184440251 4	4
LC4LD*	4304000	MicroRaves	M400s	72184441839 3	00 72184441839 3	6
LC4SD*	4304004	MicroRaves	M400s	72184441766 2	00 72184441766 2	6
LC710D*	4300710	MicroRaves	M700s	72184442229 1	00 72184442229 1	8
LC9D*	4409000	MicroRaves	M900s	72184441861 4	00 72184441861 4	4
LH1180	4331180	MicroRaves	M1100s	72184441539 2	00 72184441539 2	9
LH1180D	4331185	MicroRaves	M1100s	72184441893 5	00 72184441893 5	9
LH1200	4332000	MicroRaves	Mega-Meal	72184442630 5	00 72184442630 5	10
LH1835	4331835	MicroRaves	M1100s	72184442781 4	00 72184442781 4	9
LH2F	4492200	MicroRaves	MicroRounds	72184441297 1	00 72184441297 1	3
LH4800D*	4334810	MicroRaves	Incredi-Bowl M4800s	72184442105 8	00 72184442105 8	2
LH4LD	4334000	MicroRaves	M400s	72184441459 3	00 72184441459 3	6
LH5800D	4335802	MicroRaves	Incredi-Bowl M5800s	72184441852 2	00 72184441852 2	2
LH5800D	4335800	MicroRaves	Incredi-Bowl M5800s	72184441849 2	00 72184441849 2	2
LH5800S	4335820	MicroRaves	Incredi-Bowl M5800s	72184442359 5	00 72184442359 5	2
LH600	4331650	MicroRaves	M600s	72184442805 7	00 72184442805 7	6
LH710D	4330700	MicroRaves	M700s	72184442228 4	00 72184442228 4	8
LH712	4330712	MicroRaves	M700s	72184442231 4	00 72184442231 4	8
LH713	4330713	MicroRaves	M700s	72184442227 1	00 72184442227 1	8
LH8500	4338505	MicroRaves	Incredi-Bowl M8500s	72184442265 9	00 72184442265 9	3
LH8527	4338528	MicroRaves	Value-Bowl	72184442142 3	00 72184442142 3	3
LH9D	4339000	MicroRaves	M900s	72184441874 4	00 72184441874 4	4
M1070	4401900	MicroRaves	Rib Container	72184441890 4	00 72184441890 4	10
M1180	4591182	MicroRaves	M1100s	72184442525 4	00 72184442525 4	9
M1180D	4591185	MicroRaves	M1100s	72184441892 8	00 72184441892 8	9
M1200	4542100	MicroRaves	Mega-Meal	72184442629 9	00 72184442629 9	10
M1238	4542038	MicroRaves	Mega-Meal	72184442784 5	00 72184442784 5	10
M1280	4542080	MicroRaves	Mega-Meal	72184442628 2	00 72184442628 2	10
M1670	4402000	MicroRaves	Rib Container	72184441339 8	00 72184441339 8	10
M1825B	4591825	MicroRaves	M1100s	72184442780 7	00 72184442780 7	9
M212B	4492212	MicroRaves	MicroRounds	72184441760 0	00 72184441760 0	3
M216B	4492216	MicroRaves	MicroRounds	72184441761 7	00 72184441761 7	3
M224B	4492224	MicroRaves	MicroRounds	72184441762 4	00 72184441762 4	3
M412B	4540412	MicroRaves	M400s	72184441765 5	00 72184441765 5	6
M416B	4540416	MicroRaves	M400s	72184441833 1	00 72184441833 1	6
M424B	4540424	MicroRaves	M400s	72184441498 2	00 72184441498 2	6
M432B	4540433	MicroRaves	M400s	72184441399 2	00 72184441399 2	6
M4805B	4604802	MicroRaves	Incredi-Bowl M4800s	72184442103 4	00 72184442103 4	2
M4808B	4604804	MicroRaves	Incredi-Bowl M4800s	72184442104 1	00 72184442104 1	2
M4810B	4604810	MicroRaves	Incredi-Bowl M4800s	72184442090 7	00 72184442090 7	2
M5816B	4605816	MicroRaves	Incredi-Bowl M5800s	72184441848 5	00 72184441848 5	2
M5816B	4605817	MicroRaves	Incredi-Bowl M5800s	72184441882 9	00 72184441882 9	2
M5820B	4605821	MicroRaves	Incredi-Bowl M5800s	72184441851 5	00 72184441851 5	2
M5820B	4605820	MicroRaves	Incredi-Bowl M5800s	72184441847 8	00 72184441847 8	2
M5824B	4605824	MicroRaves	Incredi-Bowl M5800s	72184442126 3	00 72184442126 3	2
M616B	4541650	MicroRaves	M600s	72184442806 4	00 72184442806 4	6
M710B	4540700	MicroRaves	M700s	72184442224 6	00 72184442224 6	8
M710D	4540710	MicroRaves	M700s	72184442225 3	00 72184442225 3	8
M712B	4540712	MicroRaves	M700s	72184442226 0	00 72184442226 0	8
M713B	4540713	MicroRaves	M700s	72184442227 7	00 72184442227 7	8
M8524B	4608524	MicroRaves	Incredi-Bowl M8500s	72184442128 7	00 72184442128 7	3
M8527B	4608528	MicroRaves	Value-Bowl	72184442141 6	00 72184442141 6	3
M8532B	4608532	MicroRaves	Incredi-Bowl M8500s	72184442129 4	00 72184442129 4	3
M8548B	4608548	MicroRaves	Incredi-Bowl M8500s	72184442131 7	00 72184442131 7	3
M912B	4590912	MicroRaves	M900s	72184441875 1	00 72184441875 1	4
M916B	4590916	MicroRaves	M900s	72184441876 8	00 72184441876 8	4
MW810B	4608101	MicroRaves	MW800s	72184440361 0	00 72184440361 0	9
MW812B	4608121	MicroRaves	MW800s	72184440362 7	00 72184440362 7	9
MW813B	4608131	MicroRaves	MW800s	72184440363 4	00 72184440363 4	9
MW924B	4590244	MicroRaves	M900s	72184440254 5	00 72184440254 5	4
WDM1180	4110415	MicroRaves	Roasters	72184442566 7	00 72184442566 7	5
WDM1180	4110410	MicroRaves	Roasters	72184442331 1	00 72184442331 1	5

* PETE/RPET; not microwavable or heat resistant

UPC/GTIN Code by Product

Product #	SKU #	Brand	Family	UPC Code	GTIN-14 Code	Page
PETE/RPET - Cold and Non-Refrigerated Displays						
CDCP8524	4118524	CrystalClear	Crystal Classics	72184442286 4	00 72184442286 4	18
CP600	4300600	CrystalClear	Crystal Classics	72184442616 9	00 72184442616 9	18
CP608	4540608	CrystalClear	Crystal Classics	72184442613 8	00 72184442613 8	18
CP612	4540612	CrystalClear	Crystal Classics	72184442614 5	00 72184442614 5	18
CP616	4540616	CrystalClear	Crystal Classics	72184442615 2	00 72184442615 2	18
CP700	4400207	CrystalClear	Crystal Classics	72184441390 9	00 72184441390 9	18
CP724	4400247	CrystalClear	Crystal Classics	72184441388 6	00 72184441388 6	18
CP724C	4400246	CrystalClear	Crystal Classics	72184441885 0	00 72184441885 0	19
CP732	4400327	CrystalClear	Crystal Classics	72184441389 3	00 72184441389 3	19
CP800	4308100	CrystalClear	Crystal Classics	72184442272 7	00 72184442272 7	19
CP832	4548100	CrystalClear	Crystal Classics	72184442273 4	00 72184442273 4	19
CP8500	4308425	CrystalClear	Crystal Classics	72184442212 3	00 72184442212 3	18
CP8524	4548425	CrystalClear	Crystal Classics	72184442210 9	00 72184442210 9	18
CP8532	4548432	CrystalClear	Crystal Classics	72184442211 6	00 72184442211 6	18
CP8548	4408549	CrystalClear	Crystal Classics	72184442521 6	00 72184442521 6	18
CP8548C	4408548	CrystalClear	Crystal Classics	72184442520 9	00 72184442520 9	18
CPS6CD	4300610	CrystalClear	Crystal Classics	72184442824 8	00 72184442824 8	19
CPS6CF	4300601	CrystalClear	Crystal Classics	72184442823 1	00 72184442823 1	19
CPS608	4546008	CrystalClear	Crystal Classics	72184442825 5	00 72184442825 5	19
CPS612	4546012	CrystalClear	Crystal Classics	72184442826 2	00 72184442826 2	19
CPS616	4546016	CrystalClear	Crystal Classics	72184442827 9	00 72184442827 9	19
CPS700	4300700	CrystalClear	Crystal Classics	72184442673 2	00 72184442673 2	19
CPS712	4547012	CrystalClear	Crystal Classics	72184442639 8	00 72184442639 8	19
CPS716	4547016	CrystalClear	Crystal Classics	72184442674 9	00 72184442674 9	19
CPS724	4547024	CrystalClear	Crystal Classics	72184442641 1	00 72184442641 1	19
CPS820	4540820	CrystalClear	Crystal Classics	72184442649 7	00 72184442649 7	19
CPS848	4540848	CrystalClear	Crystal Classics	72184442650 3	00 72184442650 3	19
DV3708	4065179	CrystalClear	DeliView	72184442086 0	00 72184442086 0	21
DV3712	4088743	CrystalClear	DeliView	72184442085 3	00 72184442085 3	21
DV3716	4090780	CrystalClear	DeliView	72184442084 6	00 72184442084 6	21
DV4024	4540242	CrystalClear	DeliView	72184440270 5	00 72184440270 5	20
DV4032	4540322	CrystalClear	DeliView	72184440272 9	00 72184440272 9	20
DV5008	4550080	CrystalClear	DeliView	72184440168 5	00 72184440168 5	20
DV5012	4550120	CrystalClear	DeliView	72184440169 2	00 72184440169 2	20
DV5016	4550160	CrystalClear	DeliView	72184440170 8	00 72184440170 8	20
DV800S	4768001	CrystalClear	DeliView	72184440076 3	00 72184440076 3	21
DV8010	4581801	CrystalClear	DeliView	72184440228 6	00 72184440228 6	20
DV8012	4581802	CrystalClear	DeliView	72184440229 3	00 72184440229 3	20
DV8013	4581803	CrystalClear	DeliView	72184440230 9	00 72184440230 9	20
DV8048	4581805	CrystalClear	DeliView	72184440232 3	00 72184440232 3	20
DV1101	4511019	CrystalClear	DeliView	72184441202 5	00 72184441202 5	21
DVH1101B	4511017	CrystalClear	DeliView	72184441170 7	00 72184441170 7	21
FV4800	FV4800	CrystalClear	DeliView	72184440004 6	00 72184440004 6	4
FV8800	4408800	CrystalClear	DeliView	72184442522 3	00 72184442522 3	4
GC600D	4776502	CrystalClear	Gourmet Classics	72184442668 8	00 72184442668 8	4
GC600S	4776501	CrystalClear	Gourmet Classics	72184442667 1	00 72184442667 1	4
GC750D	4777502	CrystalClear	Gourmet Classics	72184442670 1	00 72184442670 1	17
GC750S	4777501	CrystalClear	Gourmet Classics	72184442669 5	00 72184442669 5	17
GC900D	4779502	CrystalClear	Gourmet Classics	72184442672 5	00 72184442672 5	17
GC900S	4779501	CrystalClear	Gourmet Classics	72184442671 8	00 72184442671 8	17
L4000	4304006	CrystalClear	DeliView	72184440266 8	00 72184440266 8	20
L5000	4305000	CrystalClear	DeliView	72184440171 5	00 72184440171 5	20
L5005	4305005	CrystalClear	DeliView	72184440172 2	00 72184440172 2	20
L8000	4380000	CrystalClear	DeliView	72184440226 2	00 72184440226 2	20
L8005	4380005	CrystalClear	DeliView	72184440227 9	00 72184440227 9	20

UPC/GTIN Code by Product

Product #	SKU #	Brand	Family	UPC Code	GTIN-14 Code	Page
Polystyrene - Cold and Non-Refrigerated						
BF1000	4010567	BonFaire		72184443001 2	00 72184443001 2	23
BF1102	4020594	BonFaire		72184443012 8	00 72184443012 8	23
BF3600	4093708	BonFaire		72184443074 6	00 72184443074 6	23
BF5200	4028217	BonFaire		72184443023 4	00 72184443023 4	23
BF5215	4096784	BonFaire		72184443076 0	00 72184443076 0	23
BF5216	4080442	BonFaire		72184443064 7	00 72184443064 7	23
BF5250	4064621	BonFaire		72184443048 7	00 72184443048 7	23
BF6200	4021614	BonFaire		72184443016 6	00 72184443016 6	23
BF9061M	4045044	BonFaire		72184443033 3	00 72184443033 3	23
GC950C3	4759503	CrystalClear	Gourmet Classics	72184441546 0	00 72184441546 0	17

Aluminum Foil						
AF121S	6401121	Anchor Foil	AF Cutter Box Rolls	72184460000 2	00 72184460000 2	25
AF181H	6402181	Anchor Foil	AF Cutter Box Rolls	72184460005 7	00 72184460005 7	25
AF181S	6401181	Anchor Foil	AF Cutter Box Rolls	72184460001 9	00 72184460001 9	25
AF185H	6402185	Anchor Foil	AF Cutter Box Rolls	72184460004 0	00 72184460004 0	25
AF185S	6401185	Anchor Foil	AF Cutter Box Rolls	72184441998 7	00 72184441998 7	25
AFP10133	6404121	Anchor Foil	AFP Pans & Lids	72184460013 2	00 72184460013 2	25
AFP1013L	6404000	Anchor Foil	AFP Pans & Lids	72184460015 6	00 72184460015 6	25
AFP21133	6404202	Anchor Foil	AFP Pans & Lids	72184460014 9	00 72184460014 9	25
AFP2113L	6404001	Anchor Foil	AFP Pans & Lids	72184460016 3	00 72184460016 3	25
AFS1211	6403220	Anchor Foil	AFS Popup Sheets	72184460044 6	00 72184460044 6	25
AFS911	6403910	Anchor Foil	AFS Popup Sheets	72184460006 4	00 72184460006 4	25
BF9800C	4051900	BonFaire		72184443039 5	00 72184443039 5	23

PVC - Foodservice Wraps and Films						
1310000	1310000	Perforated Films	Roll Film Dispensers	72184410001 4	00 72184410001 4	34
1320000	1320000	Perforated Films	Roll Film Dispensers	72184410002 1	00 72184410002 1	34
2050300	2050300	Perforated Films	Pizza Shrink	72184420047 9	00 72184420047 9	34
6503412	6503412	PurityWrap	Safety Cutters	72184410203 2	00 72184410203 2	28
6503418	6503418	PurityWrap	Safety Cutters	72184410204 9	00 72184410204 9	28
6503512	6503512	PurityWrap	Safety Cutters	72184410200 1	00 72184410200 1	28
6503518	6503518	PurityWrap	Safety Cutters	72184410201 8	00 72184410201 8	28
6503524	6503524	PurityWrap	Safety Cutters	72184410202 5	00 72184410202 5	28
7021260	7021260	UltraWrap Film	Stretch	72184471043 5	00 72184471043 5	37
7021360	7021360	UltraWrap Film	Stretch	72184471044 2	00 72184471044 2	37
7021460	7021460	UltraWrap Film	Stretch	72184471045 9	00 72184471045 9	37
7021560	7021560	UltraWrap Film	Stretch	72184471046 6	00 72184471046 6	37
7021660	7021660	UltraWrap Film	Stretch	72184471047 3	00 72184471047 3	37
7021760	7021760	UltraWrap Film	Stretch	72184471048 0	00 72184471048 0	37
7021860	7021860	UltraWrap Film	Stretch	72184471049 7	00 72184471049 7	37
7021960	7021960	UltraWrap Film	Stretch	72184471050 3	00 72184471050 3	37
7022060	7022060	UltraWrap Film	Stretch	72184471051 0	00 72184471051 0	37
7022160	7022160	UltraWrap Film	Stretch	72184471052 7	00 72184471052 7	37
7031163	7031163	UltraWrap Film	Automatic Meat	72184471165 4	00 72184471165 4	36
7031263	7031263	UltraWrap Film	Automatic Meat	72184471055 8	00 72184471055 8	36
7031463	7031463	UltraWrap Film	Automatic Meat	72184471056 5	00 72184471056 5	36
7031563	7031563	UltraWrap Film	Automatic Meat	72184471040 4	00 72184471040 4	36
7031763	7031763	UltraWrap Film	Automatic Meat	72184471041 1	00 72184471041 1	36
7031863	7031863	UltraWrap Film	Automatic Meat	72184471057 2	00 72184471057 2	36
7031963	7031963	UltraWrap Film	Automatic Meat	72184471058 9	00 72184471058 9	36
7041573	7041573	UltraWrap Film	Premium-Meat & Poultry	72184471066 4	00 72184471066 4	36
7041773	7041773	UltraWrap Film	Premium-Meat & Poultry	72184471067 1	00 72184471067 1	36
7041873	7041873	UltraWrap Film	Premium-Meat & Poultry	72184471068 8	00 72184471068 8	36
7041973	7041973	UltraWrap Film	Premium-Meat & Poultry	72184471069 5	00 72184471069 5	36
7042073	7042073	UltraWrap Film	Premium-Meat & Poultry	72184471167 8	00 72184471167 8	36
7051510	7051510	UltraWrap Film	Pro-Freezer	72184471072 5	00 72184471072 5	36
7051810	7051810	UltraWrap Film	Pro-Freezer	72184471074 9	00 72184471074 9	36
7061458	7061458	UltraWrap Film	Produce	72184471077 0	00 72184471077 0	37

UPC/GTIN Code by Product

Product #	SKU #	Brand	Family	UPC Code	GTIN-14 Code	Page
7061558	7061558	UltraWrap Film	Produce	72184471078 7	00 72184471078 7	37
7061758	7061758	UltraWrap Film	Produce	72184471080 0	00 72184471080 0	37
7061858	7061858	UltraWrap Film	Produce	72184471081 7	00 72184471081 7	37
7091850	7091850	UltraWrap Film	Miler	72184471189 0	00 72184471189 0	37
7303223	7303223	AnchorWrap	Refill Rolls-FS	72184471255 2	00 72184471255 2	29
7303283	7303283	AnchorWrap	Refill Rolls-FS	72184471256 9	00 72184471256 9	29
7303412	7303412	PurityWrap	Canadian FS Wrap	72184470898 2	00 72184470898 2	28
7303472	7303472	PurityWrap	Canadian FS Wrap	72184471012 1	00 72184471012 1	28
7303512	7303512	PurityWrap	Canadian FS Wrap	72184470889 0	00 72184470889 0	28
7303572	7303572	PurityWrap	Canadian FS Wrap	72184470894 4	00 72184470894 4	28
AW122	7318512	AnchorWrap	Premium Cling FS	72184471224 8	00 72184471224 8	29
AW182	7318518	AnchorWrap	Premium Cling FS	72184471225 5	00 72184471225 5	29
AW242	7318524	AnchorWrap	Premium Cling FS	72184471226 2	00 72184471226 2	29
CG12	CG12	Miler	Cheese Guard Cling	72184470102 0	00 72184470102 0	30
CW122	7301235	CrystalWrap	Heavy Duty Cling FS	72184471196 8	00 72184471196 8	29
CW123	7301223	CrystalWrap	Heavy Duty Cling FS	72184471239 2	00 72184471239 2	29
CW182	7301835	CrystalWrap	Heavy Duty Cling FS	72184471197 5	00 72184471197 5	29
CW183	7301823	CrystalWrap	Heavy Duty Cling FS	72184471240 8	00 72184471240 8	29
CW242	7302435	CrystalWrap	Heavy Duty Cling FS	72184471212 5	00 72184471212 5	29
CWP123	7302523	CrystalWrap Plus	Heavy Duty Cling FS	72184470810 4	00 72184470810 4	29
CWP183	7302583	CrystalWrap Plus	Heavy Duty Cling FS	72184470817 3	00 72184470817 3	29
E151010	E151010	Perforated Films	E15 Cling	72184420233 6	00 72184420233 6	32
E151111	E151111	Perforated Films	E15 Cling	72184420234 3	00 72184420234 3	32
E151212	2120120	Perforated Films	E15 Cling	72184420174 2	00 72184420174 2	32
E151414	E151414	Perforated Films	E15 Cling	72184420238 1	00 72184420238 1	32
E151515	E151515	Perforated Films	E15 Cling	72184420239 8	00 72184420239 8	32
E151616	E151616	Perforated Films	E15 Cling	72184420240 4	00 72184420240 4	32
E151818	E151818	Perforated Films	E15 Cling	72184420241 1	00 72184420241 1	32
E152222	E152222	Perforated Films	E15 Cling	72184420242 8	00 72184420242 8	32
E152418	E152418	Perforated Films	E15 Cling	72184420243 5	00 72184420243 5	32
E152428	E152428	Perforated Films	E15 Cling	72184420245 9	00 72184420245 9	32
E1565	E1565	Perforated Films	E15 Cling	72184420246 6	00 72184420246 6	32
E1588	E1588	Perforated Films	E15 Cling	72184420248 0	00 72184420248 0	32
E1599	E1599	Perforated Films	E15 Cling	72184420249 7	00 72184420249 7	32
E91212	E91212	Perforated Films	E9 Shrink	72184420120 9	00 72184420120 9	33
E91414	E91414	Perforated Films	E9 Shrink	72184420122 3	00 72184420122 3	33
E91515	E91515	Perforated Films	E9 Shrink	72184420123 0	00 72184420123 0	33
E91616	E91616	Perforated Films	E9 Shrink	72184420124 7	00 72184420124 7	33
E91717	E91717	Perforated Films	E9 Shrink	72184420125 4	00 72184420125 4	33
E91818	E91818	Perforated Films	E9 Shrink	72184420126 1	00 72184420126 1	33
E92021	E92021	Perforated Films	E9 Shrink	72184420127 8	00 72184420127 8	33
E92222	E92222	Perforated Films	E9 Shrink	72184420128 5	00 72184420128 5	33
E92424	E92424	Perforated Films	E9 Shrink	72184420129 2	00 72184420129 2	33
E93030	E93030	Perforated Films	E9 Shrink	72184420130 8	00 72184420130 8	33
E93636	E93636	Perforated Films	E9 Shrink	72184420131 5	00 72184420131 5	33
MD12	6034120	Miler	Stainless Dispenser	72184410101 1	00 72184410101 1	30
MD18	6034180	Miler	Stainless Dispenser	72184410102 8	00 72184410102 8	30
MD24	6034240	Miler	Stainless Dispenser	72184410103 5	00 72184410103 5	30
MF12	MF12	Miler	Cling FS Wrap	72184470056 6	00 72184470056 6	30
MF15	MF15	Miler	Cling FS Wrap	72184470057 3	00 72184470057 3	30
MF18	MF18	Miler	Cling FS Wrap	72184470058 0	00 72184470058 0	30
MF24	MF24	Miler	Cling FS Wrap	72184470059 7	00 72184470059 7	30
PW121	7309421	PurityWrap	Premium-Grade Cling	72184470949 1	00 72184470949 1	28
PW122	7309422	PurityWrap	Premium-Grade Cling	72184470950 7	00 72184470950 7	28
PW123	7309423	PurityWrap	Premium-Grade Cling	72184470951 4	00 72184470951 4	28
PW152	7309452	PurityWrap	Premium-Grade Cling	72184470952 1	00 72184470952 1	28
PW181	7309481	PurityWrap	Premium-Grade Cling	72184470953 8	00 72184470953 8	28
PW182	7309482	PurityWrap	Premium-Grade Cling	72184470954 5	00 72184470954 5	28
PW183	7309483	PurityWrap	Premium-Grade Cling	72184470955 2	00 72184470955 2	28
PW242	7309442	PurityWrap	Premium-Grade Cling	72184470956 9	00 72184470956 9	28
PZ1616	PZ1616	Perforated Films	Pizza Shrink	72184420042 4	00 72184420042 4	34
PZ1818	PZ1818	Perforated Films	Pizza Shrink	72184420043 1	00 72184420043 1	34
PZ2020	PZ2020	Perforated Films	Pizza Shrink	72184420044 8	00 72184420044 8	34
PZ2222	PZ2222	Perforated Films	Pizza Shrink	72184420045 5	00 72184420045 5	34
PZ2424	PZ2424	Perforated Films	Pizza Shrink	72184420046 2	00 72184420046 2	34
VW122	7300112	ValueWrap	Valu-Grade Cling FS	72184442308 3	00 72184442308 3	30
VW182	7300118	ValueWrap	Valu-Grade Cling FS	72184442309 0	00 72184442309 0	30
VW242	7300124	ValueWrap	Valu-Grade Cling FS	72184442310 6	00 72184442310 6	30

INCH
1
2
3
4
5
6
7
8
9
10



ANCHOR CARES: This Anchor Packaging catalog is printed on paper that is FSC®-certified in an FSC-certified printing facility. Paper that carries the FSC (Forest Steward Council™) certification ensures that the forest source is managed to high standards covering social, environmental and economic issues. The printing of this catalog saved 12 million BTU's of energy, 12,271 gallons of water and 27 trees. This is just one way that Anchor is making a difference to create a more sustainable tomorrow.



"BEST CLING OF ANY PLASTIC WRAP"

ANCHOR

Purity

WRAP

ALL PURPOSE FOOD FILM®



anchorpac.com

All products are eligible for recycling

©2014 Anchor Packaging, Inc - St. Louis, Missouri

reusecontainers.com